



TESLA

C Z E C H R E P U B L I C

AUTOMOBILOVÉ ŽÁROVKY A POJISTKY
AUTOMOTIVE BULBS & FUSES
АВТОМОБИЛЬНЫЕ ЛАМПЫ И ПРЕДОХРАНИТЕЛИ





LIGHTING
& protection

2016 - 2017

AUTOMOBILOVÉ ŽÁROVKY A POJISTKY **AUTOMOTIVE BULBS & FUSES**

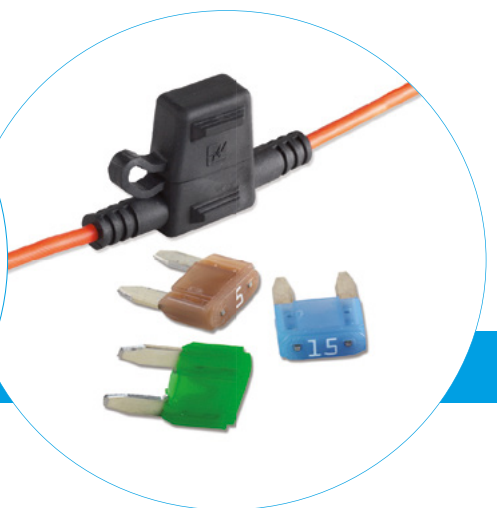
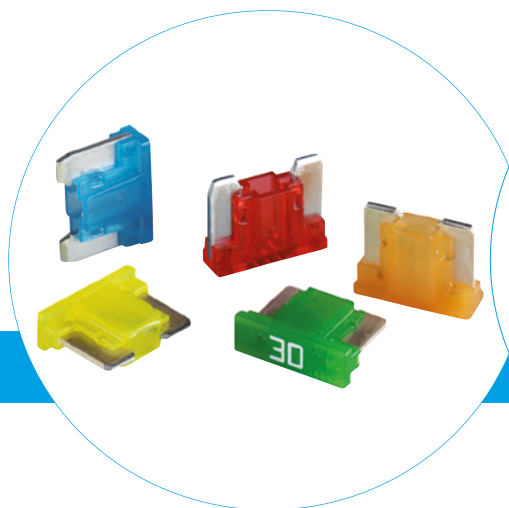
АВТОМОБИЛЬНЫЕ ЛАМПЫ И ПРЕДОХРАНИТЕЛИ
FAHRZEUGLAMPEN UND SICHERUNGEN
LAMPARAS Y FUSIBLES PARA AUTOMOVILES
LAMPES ET FUSIBLES POUR VOITURES
LAMPAD E FUSIBILI PER AUTO



AUTOMOTIVE BULBS

Автомобильные лампы

Marking, assortment

Обозначение, ассортимент 3

Halogen headlight bulbs

Галогенные лампы 4

Xenon bulbs

Ксеноновые лампы 9

Bulbs with metallic base

Лампы с металлическим цоколем 11

Festoons

Софитные лампы 12

Glass bulbs – wedge base

Бесцокольные лампы 13

Bulbs with plastic base

Лампы с пластмассовым цоколем (в патроне) 15

Spare kits

Сервисный набор ламп и предохранителей 17

Packing

Упаковка 19

Bulbs application

Применение автомобильных ламп 20

MARKING - CATALOGUE NUMBER OF TESLA BULBS

Обозначение ламп TESLA, каталожный номер для заказа

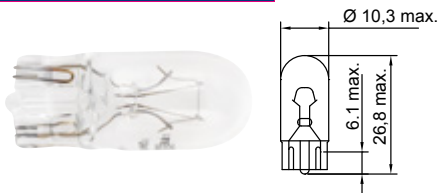
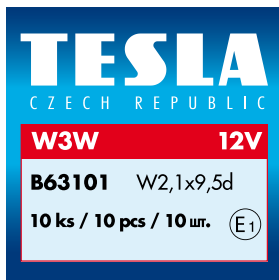

Catalogue number (Type-No.) **B u x y z v (B63101)**

type of bulb / тип лампы:

xyz = code / код

voltage / напряжение:

- 1 – halogen / галогенная
- 2 – xenon / ксеноновая
- 3 – higher intensity / с увеличенной светоотдачи (plus 50 %)
- 5 – metallic base / с металлическим цоколем
- 6 – glass (wedge base) / бесцокольные
- 7 – plastic base / с пластмассовым цоколем
- 8 – festoon / софитные

- 1 – 12V
- 2 – 24V
- 4 – 42V
- 5 – 85V

Type-No.	ECE	V	W	socket	pcs-шт.	info
B63101	W3W	12	3	W2,1x9,5d	10	
B63102	W3W	24	3	W2,1x9,5d	10	

Dimensions in mm / Размеры в мм, Type-No. = Каталожный номер, ECE= ECE R37 code / ECE R37 код, socket = цоколь, pcs – шт. = packing quantity / упаковка

BULBS ASSORTMENT - SUMMARY

Ассортимент автомобильных ламп - перечень

ECE	Type-No.	V	ECE	Type-No.	V	ECE	Type-No.	V
C5W	B85301	12	H16	B11601	12	T4W	B54101	12
C5W	B85302	24	H21W	B17201	12	T4W	B54102	24
D1R	B21105	85	H27W/1	B12711	12	W2,3W	B62101	12
D1S	B21005	85	H27W/2	B12721	12	W3W	B63101	12
D2R	B22105	85	HB1	B18101	12	W3W	B63102	24
D2S	B22005	85	HB3	B18301	12	W5W	B65201	12
D3R	B23104	42	HB4	B18401	12	W5W	B65202	24
D3S	B23004	42	HB5	B18501	12	WY5W	B65301	12
D4R	B24104	42	P21W	B52101	12	W16W	B66101	12
D4S	B24004	42	P21W	B52102	24	WY16W	B66201	12
H1	B10101	12	PY21W	B58301	12	W21W	B62201	12
H1 (plus 50)	B30101	12	PY21W	B52301	12	WY21W	B62301	12
H1	B10102	24	PY21W	B52302	24	W21/5W	B62401	12
H3	B10301	12	P21/4W	B52401	12	WY21/5W	B62501	12
H3	B10302	24	P21/5W	B52201	12	x (1,2W)	B67101	12
H4	B10401	12	P21/5W	B52202	24	x (1,2W)	B67102	24
H4 (P45t)	B10451	12	PY21/5W	B52501	12	x (1,2W)	B77201	12
H4 (plus 50)	B30401	12	P27W	B77291	12	x (1,2W)	B77202	24
H4	B10402	24	PY27W	B77311	12	x (1,1W)	B77211	12
H6W	B17101	12	P27/7W	B77301	12	x (1,2W)	B77221	12
H7	B10701	12	PY27/7W	B77321	12	x (1,2W)	B77281	12
H7 (plus 50)	B30701	12	R5W	B55101	12	x (1,3W)	B77231	12
H7	B10702	24	R5W	B55102	24	x (1,5W)	B77241	12
H8	B10801	12	R10W	B56101	12	x (1,5W)	B77261	12
H9	B10901	12	R10W	B56102	24	x (2W)	B77251	12
H10W	B17301	12	RY10W	B56201	12	x (2W)	B77271	12
H11	B11101	12				x (10W)	B86201	12
H15	B11501	12				x (10W)	B86202	24

HALOGEN HEADLIGHT BULBS

Галогенные лампы головного света

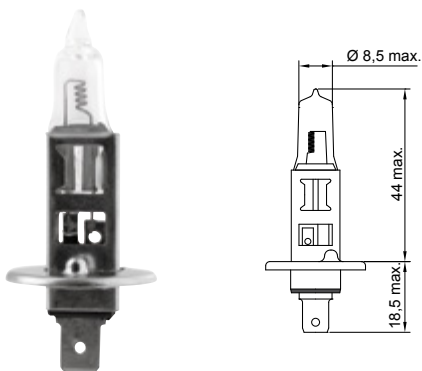

H1

Type-No.	ECE	V	W	socket	pcs-шт.	info
B10101	H1	12	55	P14,5s	1	
B30101	H1	12	55	P14,5s	1	plus 50%
B10102	H1	24	70	P14,5s	1	

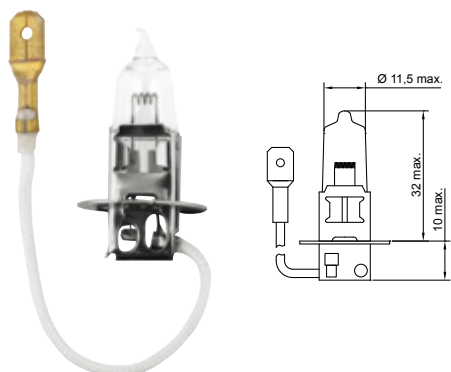

H3

Type-No.	ECE	V	W	socket	pcs-шт.	info
B10301	H3	12	55	PK22s	1	
B10302	H3	24	70	PK22s	1	

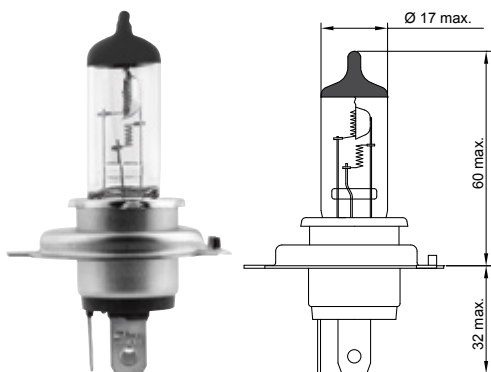

H4

Type-No.	ECE	V	W	socket	pcs-шт.	info
B10401	H4	12	60/55	P43t	1	
B30401	H4	12	60/55	P43t	1	plus 50%
B10402	H4	24	75/70	P43t	1	

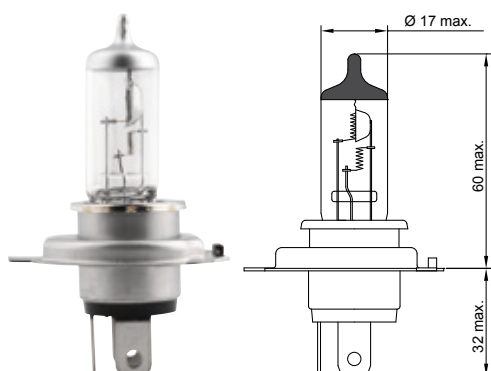

H4

Type-No.	ECE	V	W	socket	pcs-шт.	info
B10451	H4	12	60/55	P45t	1	

HALOGEN HEADLIGHT BULBS

Галогенные лампы головного света

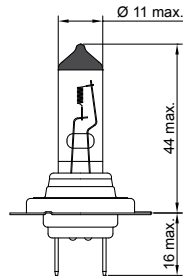

H7

Type-No.	ECE	V	W	socket	pcs-шт.	info
B10701	H7	12	55	PX26d	1	
B30701	H7	12	55	PX26d	1	plus 50%
B10702	H7	24	70	PX26d	1	

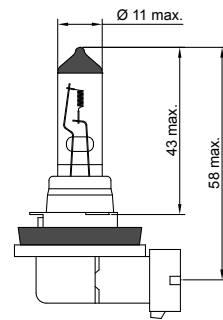

H8

Type-No.	ECE	V	W	socket	pcs-шт.	info
B10801	H8	12	35	PGJ19-1	1	

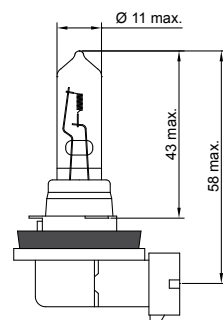

H9

Type-No.	ECE	V	W	socket	pcs-шт.	info
B10901	H9	12	65	PGJ19-5	1	

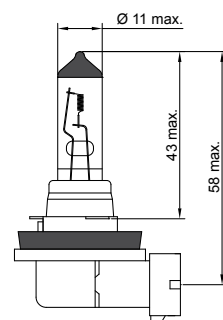

H11

Type-No.	ECE	V	W	socket	pcs-шт.	info
B11101	H11	12	55	PGJ19-2	1	

HALOGEN HEADLIGHT BULBS

Галогенные лампы головного света

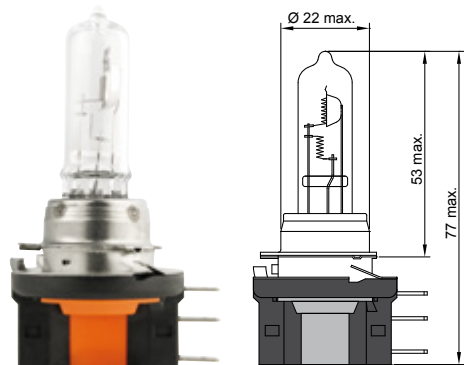

H15

Type-No.	ECE	V	W	socket	pcs-шт.	info
B11501	H15	12	55/15	PGJ23t-1	1	

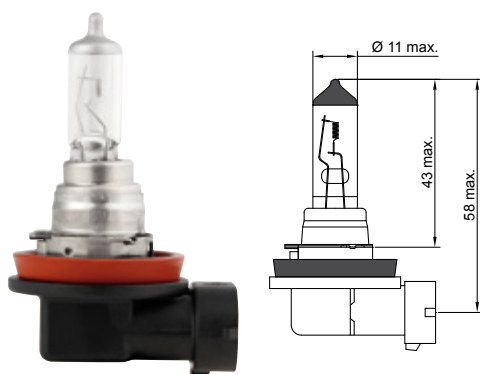

H16

Type-No.	ECE	V	W	socket	pcs-шт.	info
B11601	H16	12	19	PGJ19-3	1	

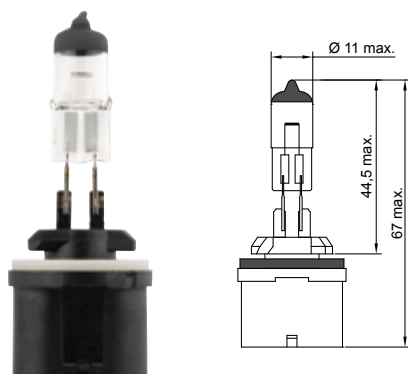

H27W/1

Type-No.	ECE	V	W	socket	pcs-шт.	info
B12711	H27W/1	12	27	PG13	1	880-SAE

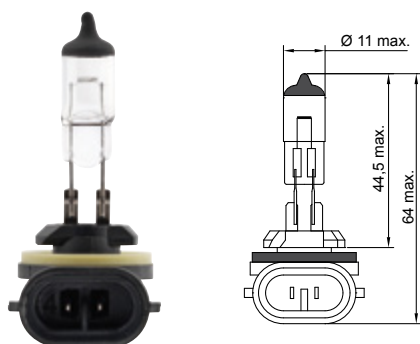

H27W/2

Type-No.	ECE	V	W	socket	pcs-шт.	info
B12721	H27W/2	12	27	PGJ13	1	881-SAE

HALOGEN HEADLIGHT BULBS

Галогенные лампы головного света



HB1

Type-No.	ECE	V	W	socket	pcs-шт.	info
B18101	HB1	12	65/45	P29t	1	9004-SAE

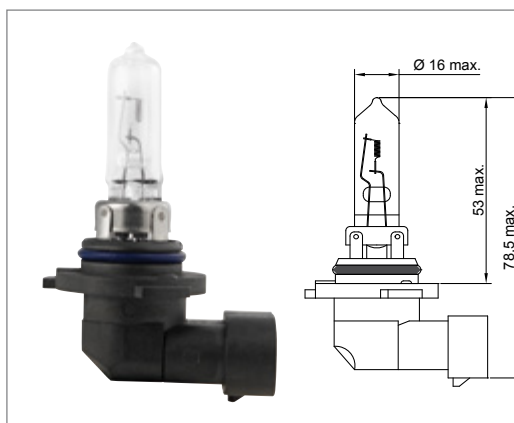

HB3

Type-No.	ECE	V	W	socket	pcs-шт.	info
B18301	HB3	12	60	P20d	1	9005-SAE

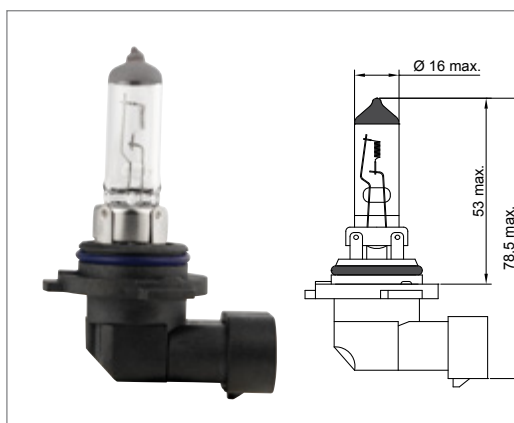

HB4

Type-No.	ECE	V	W	socket	pcs-шт.	info
B18401	HB4	12	51	P22d	1	9006-SAE

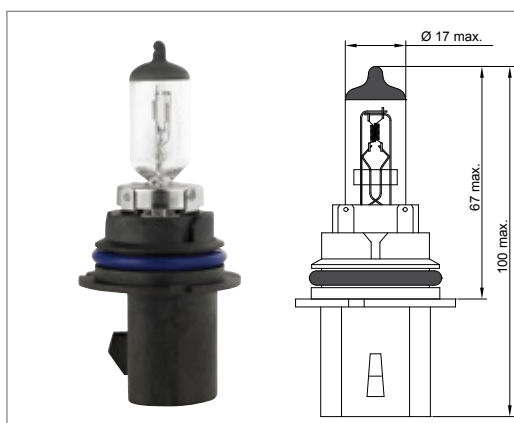

HB5

Type-No.	ECE	V	W	socket	pcs-шт.	info
B18501	HB5	12	65/55	PX29t	1	9007-SAE

HALOGEN BULBS - MINIATURE

Галогенные лампы - мини

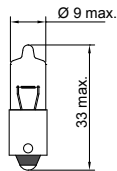
H6W

Type-No.	ECE	V	W	socket	pcs-шт.	info
B17101	H6W	12	6	BAX9s	10	miniature

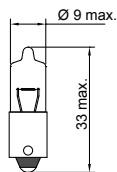
H10W

Type-No.	ECE	V	W	socket	pcs-шт.	info
B17301	(H10W)	12	10	BA9s	10	miniature

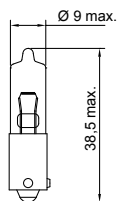
H21W

Type-No.	ECE	V	W	socket	pcs-шт.	info
B17201	H21W	12	21	BAY9s	10	miniature

XENON HEADLIGHT BULBS

Ксеноновые лампы головного света

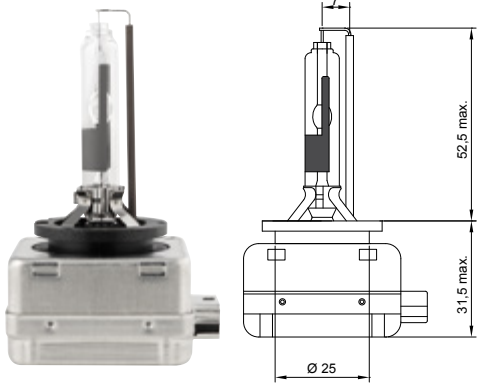

D1R

Type-No.	ECE	V	W	socket	pcs-шт.	info
B21105	D1R	85	35	PK32d-3	1	

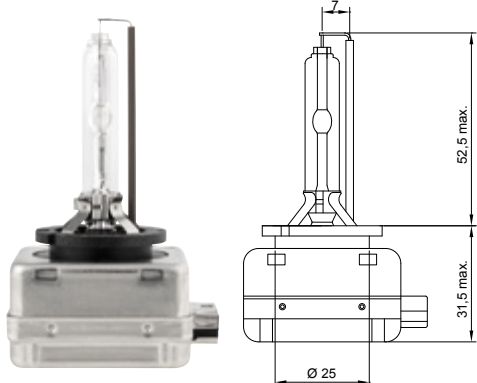

D1S

Type-No.	ECE	V	W	socket	pcs-шт.	info
B21005	D1S	85	35	PK32d-2	1	

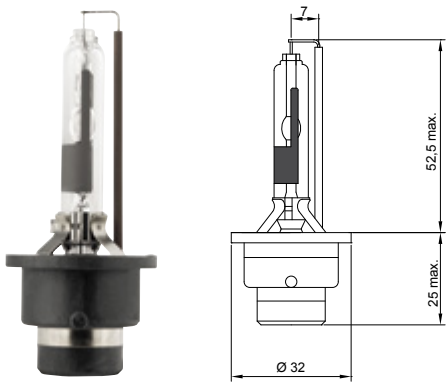

D2R

Type-No.	ECE	V	W	socket	pcs-шт.	info
B22105	D2R	85	35	P32d-3	1	

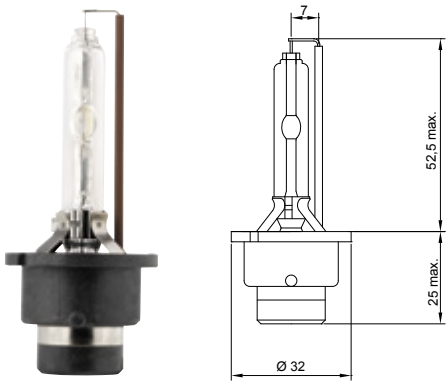

D2S

Type-No.	ECE	V	W	socket	pcs-шт.	info
B22005	D2S	85	35	P32d-2	1	

XENON HEADLIGHT BULBS

Ксеноновые лампы головного света

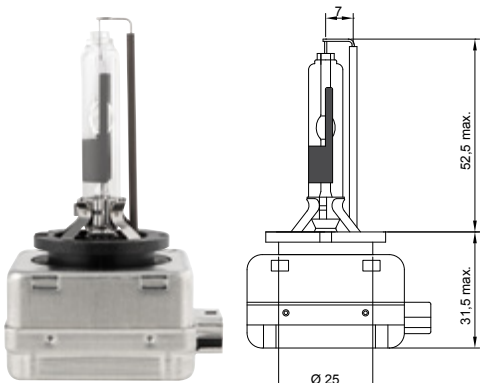

D3R

Type-No.	ECE	V	W	socket	pcs-шт.	info
B23104	D3R	42	35	PK32d-6	1	

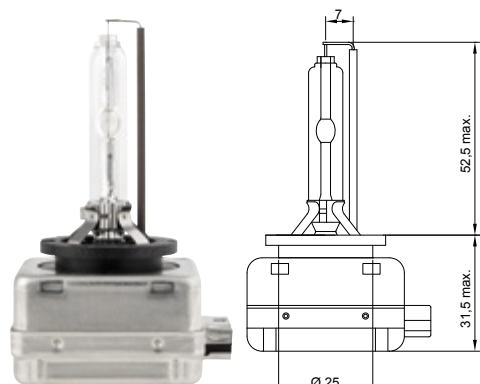

D3S

Type-No.	ECE	V	W	socket	pcs-шт.	info
B23004	D3S	42	35	PK32d-5	1	

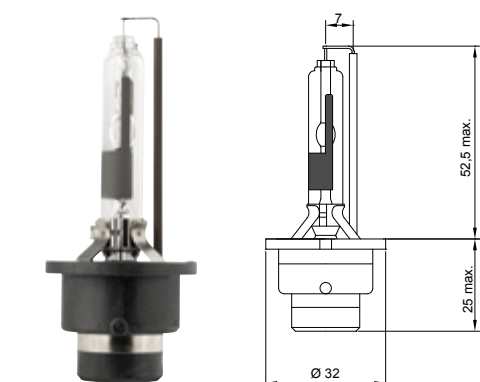

D4R

Type-No.	ECE	V	W	socket	pcs-шт.	info
B24104	D4R	42	35	P32d-6	1	

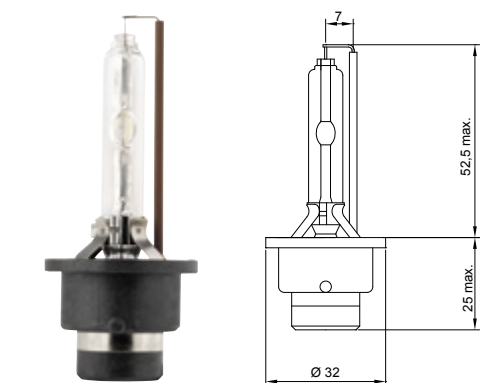

D4S

Type-No.	ECE	V	W	socket	pcs-шт.	info
B24004	D4S	42	35	P32d-5	1	

BULBS WITH METALIC BASE (socket)

Лампы с металлическим цоколем

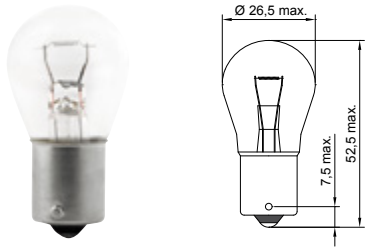

P21W

Type-No.	ECE	V	W	socket	pcs-шт.	info
B52101	P21W	12	21	BA15s	10	
B52102	P21W	24	21	BA15s	10	

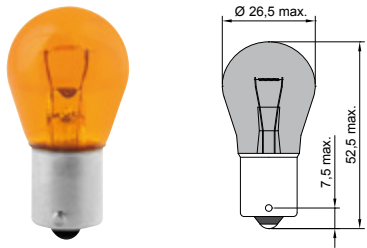

PY21W

Type-No.	ECE	V	W	socket	pcs-шт.	info
B58301	PY21W	12	21	BA15s	10	

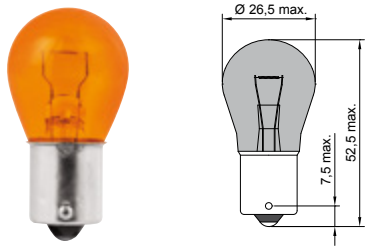

PY21W

Type-No.	ECE	V	W	socket	pcs-шт.	info
B52301	PY21W	12	21	BAU15s	10	
B52302	PY21W	24	21	BAU15s	10	



P21/4W

Type-No.	ECE	V	W	socket	pcs-шт.	info
B52401	P21/4W	12	21/4	BAZ15d	10	

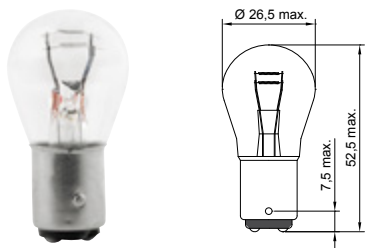

P21/5W

Type-No.	ECE	V	W	socket	pcs-шт.	info
B52201	P21/5W	12	21/5	BAY15d	10	
B52202	P21/5W	24	21/5	BAY15d	10	

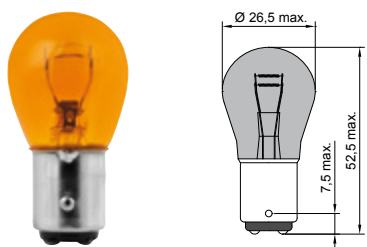



PY21/5W

Type-No.	ECE	V	W	socket	pcs-шт.	info
B52501	PY21/5W	12	21/5	BAY15d	10	

BULBS WITH METALIC BASE (socket)

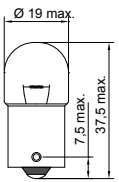
Лампы с металлическим цоколем

 	R5W						
	Type-No.	ECE	V	W	socket	pcs-шт.	info
	B55101	R5W	12	5	BA15s	10	
	B55102	R5W	24	5	BA15s	10	

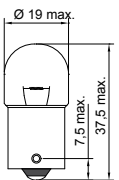
 	R10W						
	Type-No.	ECE	V	W	socket	pcs-шт.	info
	B56101	R10W	12	10	BA15s	10	
	B56102	R10W	24	10	BA15s	10	

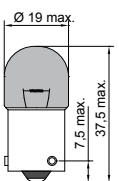
 	RY10W						
	Type-No.	ECE	V	W	socket	pcs-шт.	info
	B56201	RY10W	12	10	BAU15s	10	

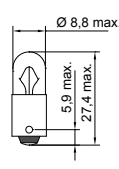
 	T4W						
	Type-No.	ECE	V	W	socket	pcs-шт.	info
	B54101	T4W	12	4	BA9s	10	
	B54102	T4W	24	4	BA9s	10	

FESTOONS

Софитные лампы

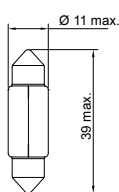
 	C5W						
	Type-No.	ECE	V	W	socket	pcs-шт.	info
	B85301	C5W	12	5	SV8,5-8	10	
	B85302	C5W	24	5	SV8,5-8	10	

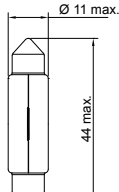
 	10W						
	Type-No.	ECE	V	W	socket	pcs-шт.	info
	B86201		12	10	SV8,5-8	10	
	B86202		24	10	SV8,5-8	10	

GLASS BULBS – WEDGE BASE (socket)

Бесцветные лампы

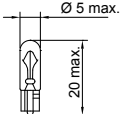
1,2W

Type-No.	ECE	V	W	socket	pcs-шт.	info
B67101		12	1,2	W2x4,6d	10	
B67102		24	1,2	W2x4,6d	10	

W2,3W

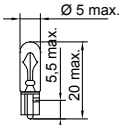
Type-No.	ECE	V	W	socket	pcs-шт.	info
B62101	W2,3W	12	2,3	W2x4,6d	10	

W3W

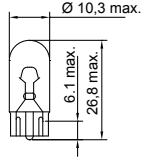
Type-No.	ECE	V	W	socket	pcs-шт.	info
B63101	W3W	12	3	W2,1x9,5d	10	
B63102	W3W	24	3	W2,1x9,5d	10	

W5W

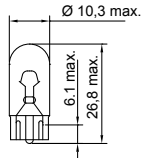
Type-No.	ECE	V	W	socket	pcs-шт.	info
B65201	W5W	12	5	W2,1x9,5d	10	
B65202	W5W	24	5	W2,1x9,5d	10	



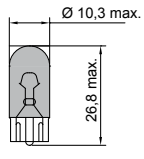

WY5W

Type-No.	ECE	V	W	socket	pcs-шт.	info
B65301	WY5W	12	5	W2,1x9,5d	10	

GLASS BULBS – WEDGE BASE (socket)

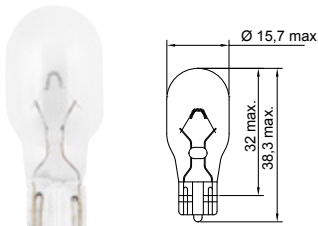
Бесцокольные лампы



W16W

Type-No.	ECE	V	W	socket	pcs-шт.	info
B66101	W16W	12	16	W2,1x9,5d	10	

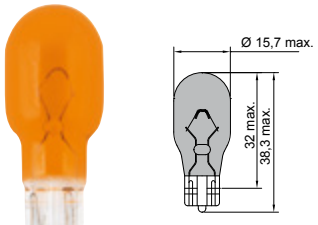

WY16W

Type-No.	ECE	V	W	socket	pcs-шт.	info
B66201	WY16W	12	16	W2,1x9,5d	10	

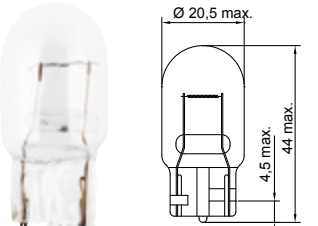

W21W

Type-No.	ECE	V	W	socket	pcs-шт.	info
B62201	W21W	12	21	W3x16d	10	

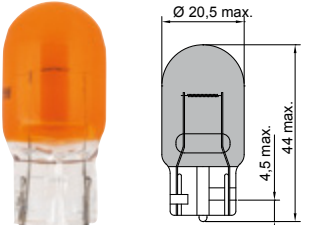

WY21W

Type-No.	ECE	V	W	socket	pcs-шт.	info
B62301	WY21W	12	21	WX3x16d	10	

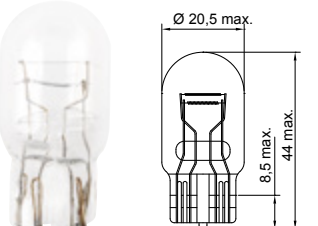

W21/5W

Type-No.	ECE	V	W	socket	pcs-шт.	info
B62401	W21/5W	12	21/5	W3x16q	10	

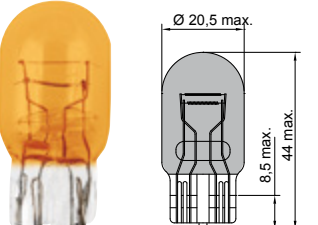

WY21/5W

Type-No.	ECE	V	W	socket	pcs-шт.	info
B62501	WY21/5W	12	21/5	W3x16q	10	

BULBS WITH PLASTIC BASE (socket)

Лампы с пластмассовым цоколем (в патроне)

	P27W						
	Type-No.	ECE	V	W	socket	pcs-шт.	info
	B77291	P27W	12	27	W2,5x16d	10	
	PY27W						
	Type-No.	ECE	V	W	socket	pcs-шт.	info
	B77311	PY27W	12	27	WY2,5x16d	10	
	P27/7W						
	Type-No.	ECE	V	W	socket	pcs-шт.	info
	B77301	P27/7W	12	27/7	W2,5x16q	10	
	PY27/7W						
	Type-No.	ECE	V	W	socket	pcs-шт.	info
	B77321	PY27/7W	12	27/7	WY2,5x16q	10	





BULBS WITH PLASTIC BASE (socket) - dashboard light

Лампы с пластмассовым цоколем (в патроне) - приборная панель

	1,1W						
	Type-No.	ECE	V	W	socket	pcs-шт.	info
	B77211		12	1,1	B8,4d	10	
	1,2W						
	Type-No.	ECE	V	W	socket	pcs-шт.	info
	B77221		12	1,2	B8,4d	10	

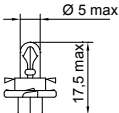
BULBS WITH PLASTIC BASE (socket) - dashboard light

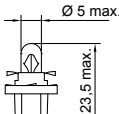
Лампы с пластмассовым цоколем (в патроне) - приборная панель

 	1,3W						
	Type-No.	ECE	V	W	socket	pcs-шт.	info
	B77231		12	1,3	B8,4d	10	
 	1,5W						
	Type-No.	ECE	V	W	socket	pcs-шт.	info
	B77241		12	1,5	B8,4d	10	
 	2W						
	Type-No.	ECE	V	W	socket	pcs-шт.	info
	B77251		12	2,0	B8,4d	10	
 	1,2W						
	Type-No.	ECE	V	W	socket	pcs-шт.	info
	B77201		12	1,2	B8,5d	10	(BAX10d)
	B77202		24	1,2	B8,5d	10	(BAX10d)
 	1,5W						
	Type-No.	ECE	V	W	socket	pcs-шт.	info
	B77261		12	1,5	B8,5d	10	(BAX10d)
 	2W						
	Type-No.	ECE	V	W	socket	pcs-шт.	info
	B77271		12	2,0	B8,5d	10	(BAX10d)
 	1,2W						
	Type-No.	ECE	V	W	socket	pcs-шт.	info
	B77281		12	1,2	B8,7d	10	

SPARE KITS

Сервисный набор ламп и предохранителей

12V



Kit Type - order code (1 pc)			
Набор - каталожный номер (1 шт.)			
	BH0101	BH0401	BH0701
bulbs / лампы 12V - pc / шт.			
H1	1		
H4		1	
H7			1
R5W	1	1	1
P21W	1	1	1
P21/5W	1	1	1
PY21W	1	1	1
W5W	1	1	1
fuses / предохранители - pc / шт.			
ATO 7,5A	1	1	1
ATO 10A	1	1	1
ATO 15A	1	1	1
ATO 20A	1	1	1



Kit Type - order code (1 pc)			
Набор - каталожный номер (1 шт.)			
	BS0101	BS0401	BS0701
bulbs / лампы 12V - pc / шт.			
H1	1		
H4		1	
H7			1
R5W	1	1	1
P21W	1	1	1
W5W	1	1	1
fuses / предохранители - pc / шт.			
ATO 10A	1	1	1
ATO 15A	1	1	1
ATO 20A	1	1	1

SPARE KITS

Сервисный набор ламп и предохранителей

24V



Kit Type - order code (1 pc)			
Набор - каталожный номер (1 шт.)			
	BH0102	BH0402	BH0702
bulbs / лампы 24V - pc / шт.			
H1	1		
H4		1	
H7			1
R5W	1	1	1
P21W	1	1	1
P21/5W	1	1	1
PY21W	1	1	1
W5W	1	1	1
fuses / предохранители - pc / шт.			
ATO 7,5A	1	1	1
ATO 10A	1	1	1
ATO 15A	1	1	1
ATO 20A	1	1	1



Kit Type - order code (1 pc)			
Набор - каталожный номер (1 шт.)			
	BS0102	BS0402	BS0702
bulbs / лампы 24V - pc / шт.			
H1	1		
H4		1	
H7			1
R5W	1	1	1
P21W	1	1	1
W5W	1	1	1
fuses / предохранители - pc / шт.			
ATO 10A	1	1	1
ATO 15A	1	1	1
ATO 20A	1	1	1

PACKING MULTIBOX

Упаковка мульти бокс

12V

12V bulbs with plastic (glass) base

12V лампы с пластмассовым цоколем (бесцокольные)

Order code / Каталогный номер
BBOX.001.160

ECE	W	socket	pcs-шт.	Type-No.
(BAX)	1,1	B8,4d	10	B77211
(BAX)	1,2	B8,4d	10	B77221
(BAX)	1,3	B8,4d	10	B77231
(BAX)	1,5	B8,4d	10	B77241
(BAX)	2,0	B8,4d	10	B77251
(BAX)	1,2	B8,5d	10	B77201
(BAX)	1,5	B8,5d	10	B77261
(BAX)	2,0	B8,5d	10	B77271
(BAX)	1,2	B8,7d	10	B77281
(1,2W)	1,2	W2x4,6d	30	B67101
W2,3W	2,3	W2x4,6d	30	B62101
W5W	5	W2,1x9,5d	10	B65201

160 pcs-шт.

(180 x 130 x 25 mm)

PROMOTION STAND

Стенд для продажи

12V, 24V

Order code / Каталогный номер: 49010071

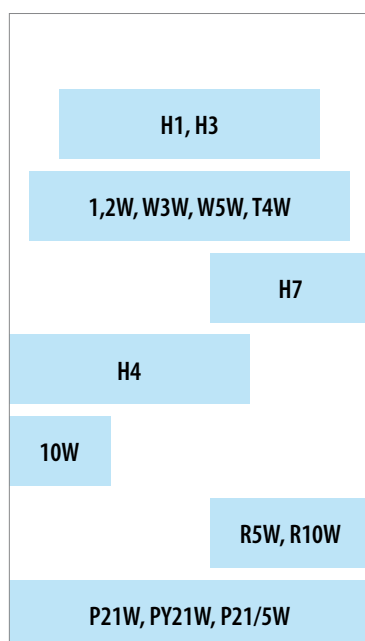

12V	24V
H1, H1+50	H1
H3	H3
H4, H4+50	H4
H7, H7+50	H7
P21W	P21W
PY21W	PY21W
P21/5W	P21/5W
R5W	R5W
R10W	R10W
T4W	T4W
W3W	W3W
W5W	W5W
C5W	C5W
10W	10W
BAX 1,2W	BAX 1,2W
1,2W	1,2W

• for boxes with 12V, 24V bulbs (see table), dimensions: 500 x 300 x 140 mm, cost free stand is delivered without bulbs

• для упаковок 12V, 24V ламп по 1 и 10 шт. (см. таблицу), размеры: 500 x 300 x 140 mm, бесплатный стенд не содержит отдельные упаковки ламп

PACKING QUANTITY

12V, 24V

Упаковки по 1 шт., 10 шт., 100 и 200 шт.

1 pc / 1 шт.			10 pcs / 10 шт.			10 pcs / 10 шт.		
ECE	Type-No.	V	ECE	Type-No.	V	ECE	Type-No.	V
D1R	B21105	85	C5W	B85301	12	W2,3W	B62101	12
D1S	B21005	85	C5W	B85302	24	W3W	B63101	12
D2R	B22105	85	H6W	B17101	12	W3W	B63102	24
D2S	B22005	85	H10W	B17301	12	W5W	B65201	12
D3R	B23104	42	H21W	B17201	12	W5W	B65202	24
D3S	B23004	42	P21W	B52101	12	W16W	B66101	12
D4R	B24104	42	P21W	B52102	24	W21W	B62201	12
D4S	B24004	42	P21/4W	B52401	12	W21/5W	B62401	12
H1	B10101	12	P21/5W	B52201	12	WY5W	B65301	12
H1 (plus 50)	B30101	12	P21/5W	B52202	24	WY16W	B66201	12
H1	B10102	24	P27W	B77291	12	WY21W	B62301	12
H3	B10301	12	P27/7W	B77301	12	WY21/5W	B62501	12
H3	B10302	24	PY21W	B58301	12	x (1,2W)	B67101	12
H4	B10401	12	PY21W	B52301	12	x (1,2W)	B67102	24
H4 (P45t)	B10451	12	PY21W	B52302	24	x (1,2W)	B77201	12
H4 (plus 50)	B30401	12	PY21/5W	B52501	12	x (1,2W)	B77202	24
H4	B10402	24	PY27W	B77311	12	x (1,1W)	B77211	12
H7	B10701	12	PY27/7W	B77321	12	x (1,2W)	B77221	12
H7 (plus 50)	B30701	12	R5W	B55101	12	x (1,2W)	B77281	12
H7	B10702	24	R5W	B55102	24	x (1,3W)	B77231	12
H8	B10801	12	R10W	B56101	12	x (1,5W)	B77241	12
H9	B10901	12	R10W	B56102	24	x (1,5W)	B77261	12
H11	B11101	12	RY10W	B56201	12	x (2W)	B77251	12
H15	B11501	12	T4W	B54101	12	x (2W)	B77271	12
H16	B11601	12	T4W	B54102	24	x (10W)	B86201	12
H27W/1	B12711	12				x (10W)	B86202	24
H27W/2	B12721	12						
HB1	B18101	12						
HB3	B18301	12						
HB4	B18401	12						
HB5	B18501	12						



APPLICATION OF 12V TESLA BULBS

12V

Применение автомобильных ламп на 12V

front light / дальний - ближний свет

D1R D1S D2R D2S D3R D3S D4R D4S H1 H4 H7 H8 H9 H11 H15

fog light / противотуманные

H1 H3 H7 H8 H11 H16 HB3 HB4 H27W/1 H27W/2

front light / дальний - ближний свет

HB1 HB3 HB4 HB5

side signals / указатели поворота

P21W PY21W P27/7W W21W WY21W

parking, warning light / стояночное, габаритное освещение

R5W R10W T4W W5W H6W W21W

dashboard light / лампы приборной панели

W3W W5W W2,3W 1,2W 1,2W
1,1W 1,2W 1,3W 1,5W 2W

side turn signals / боковые указатели поворота

R5W T4W W5W WY5W H21W

interior light / внутреннее освещение

C5W W5W 10W H10W

side signals / указатели поворота

P21W PY21W P27/7W WY21W

parking, warning light / стояночное, габаритное освещение

P21/5W R10W W21/5W H6W

stop signals / стоп-сигналы

P21/5W
P21W P21/4W P27/7W W21W W21/5W

licence plate / освещение номерного знака

C5W R5W R10W W5W

fog light / противотуманные

W16W W21W H21W P21W P21/4W

reverse light / задний ход

P21W P27W W16W H21W

APPLICATION OF 24V TESLA BULBS

24V

Применение автомобильных ламп на 24V

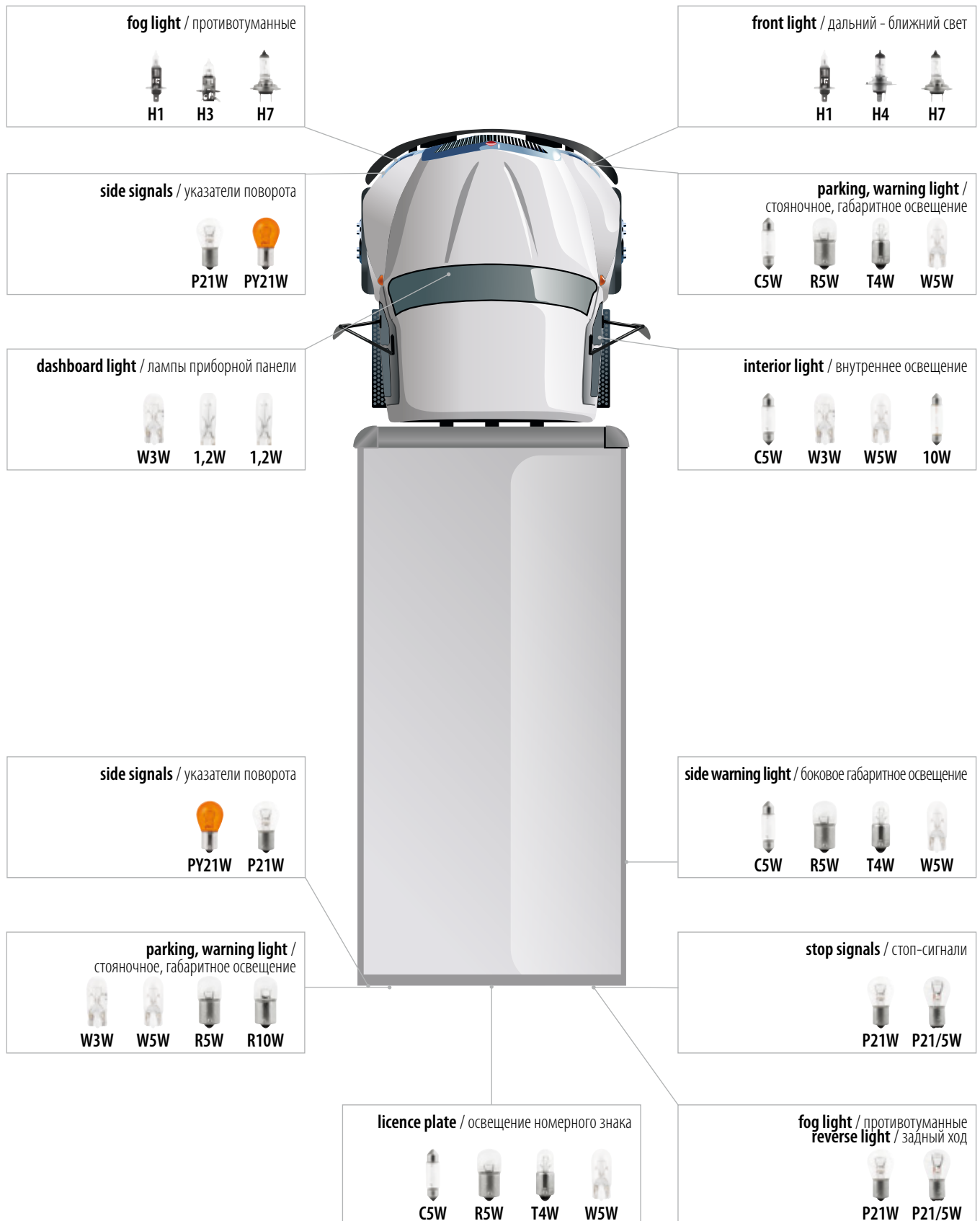

BASES - SOCKETS

Цоколи ламп

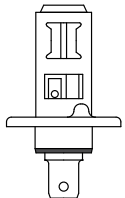
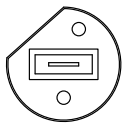
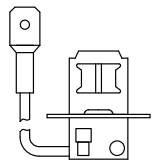
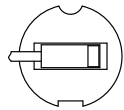
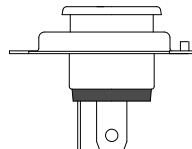
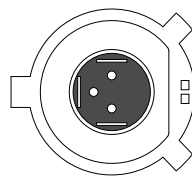
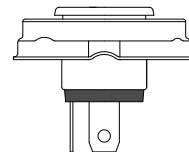
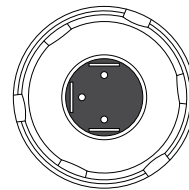
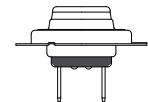
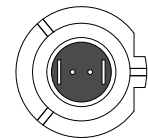
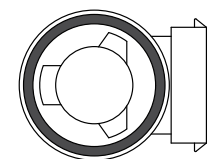
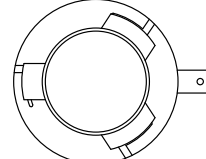
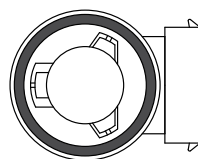
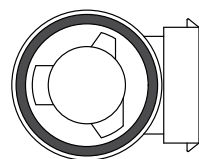
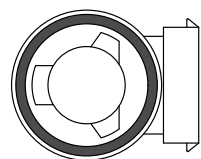
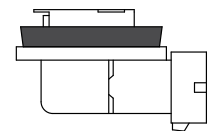
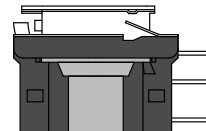
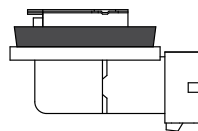
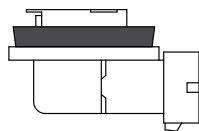
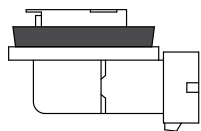
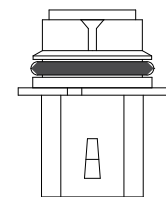
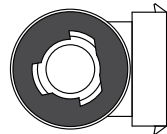
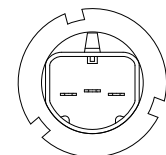
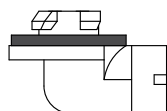
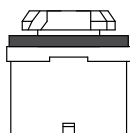
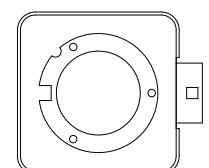
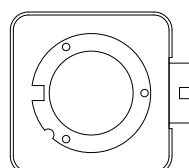
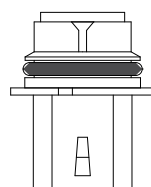
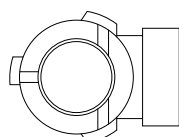
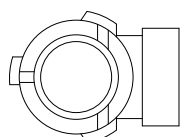
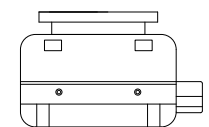
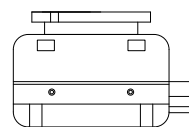
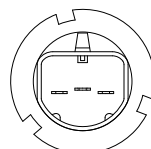
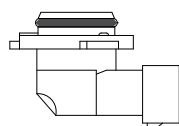
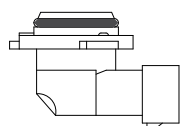
H1 - P14,5s

H3 - PK22s

H4 - P43t

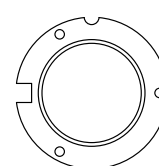
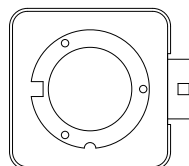
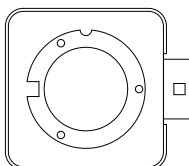
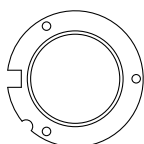
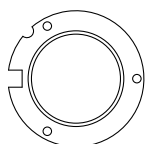
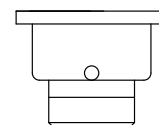
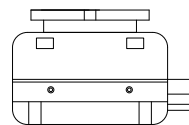
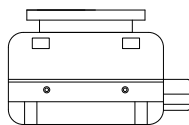
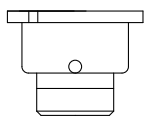
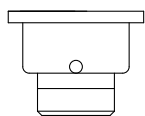
H4 - P45t

H7 - PX26d

H8 - PGJ19-1
H9 - PGJ19-5
H11 - PGJ19-2
H15 - PGJ23t-1
H16 - PGJ19-3

H27W/1 - PG13
H27W/2 - PG13
H6W - BAX9s
H10W - BA9s
H21W - BAY9s
HB1 - P29t

HB3 - P20d
HB4 - P22d
HB5 - PX29t
D1S - PK32d-2
D1R - PK32d-3

BASES - SOCKETS

Цоколи ламп



D2R - P32d-3

D2S - P32d-2

D3S - PK32d-5

D3R - PK32d-6

D4S - P32d-5

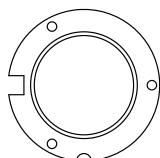
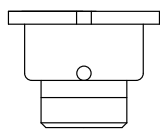

D4R - P32d-6

P21W, PY21W, R5W, R10W - BA15s

PY21W - BAU15s

P21/4W - BAZ15d

P21/5W, PY21/5W - BAY15d



RY10W - BAU15s

R5W, R10W - BA15s

T4W - BA9s

C5W, C10W - SV8,5-8



Glass - wedge base

W2x4,6d

W2,1x9,5d

W3x16d

W3x16q

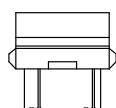
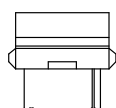

Plastic base

W2,5x16d

W2,5x16q

B8,4d

B8,5d

B8,7d

AUTOMOTIVE FUSES

Автомобильные предохранители

Blade fuses Плоские предохранители.....	26
Glow blade fuses Плоские предохранители с индикатором LED	29
Bolt down fuses MIDI Предохранители MIDI	31
Bolt down fuses MEGA Предохранители MEGA.....	31
Main fuses Компактные предохранители	32
Strip fuses Ленточные предохранители	32
Cartridge fuses Предохранители картриджного типа.....	36
Continental (torpedo) fuses Предохранители торпедо	43
Glass fuses Стеклянные предохранители.....	43
Blister packing Упаковка блистер	45
Special packing Сборная упаковка.....	48
Multibox packing Упаковка мульти бокс	50
Blade fuses tester Тестер для плоских предохранителей	54

Dimensions in mm / Размеры в мм

FUSES - PACKING

Предохранители - упаковка

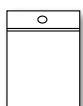

Single packing - plastic bag
Индивидуальная упаковка - пакетик

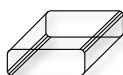

Box packing - plastic boxes
Групповая упаковка - пластиковые коробки



Industrial packing - carton
Промышленная упаковка - картонная коробка



Blister packing
Упаковка блистер



Multi packing
Упаковка мульти бокс



MICRO2 BLADE FUSES

Плоские предохранители MICRO2

FR02 serie 32V DC

Type	Color	Packing unit - order code		
		Упаковка - каталожный номер		
Тип	Цвет	1 pc / шт.	10 pcs / шт.	100 pcs / шт.
FR02 5A		FR02.005.001	FR02.005.010	FR02.005.100
FR02 7,5A		FR02.075.001	FR02.075.010	FR02.075.100
FR02 10A		FR02.010.001	FR02.010.010	FR02.010.100
FR02 15A		FR02.015.001	FR02.015.010	FR02.015.100
FR02 20A		FR02.020.001	FR02.020.010	FR02.020.100
FR02 25A		FR02.025.001	FR02.025.010	FR02.025.100
FR02 30A		FR02.030.001	FR02.030.010	FR02.030.100

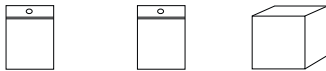
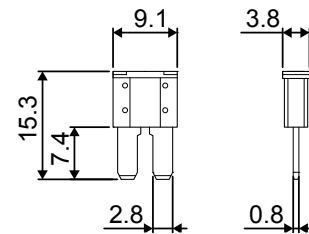
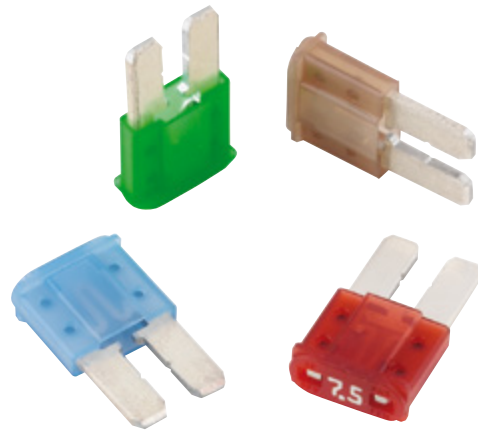

MICRO3 BLADE FUSES

Плоские предохранители MICRO3

FR03 serie 32V DC

Type	Color	Packing unit - order code		
		Упаковка - каталожный номер		
Тип	Цвет	1 pc / шт.	10 pcs / шт.	100 pcs / шт.
FR03 5A		FR03.005.001	FR03.005.010	FR03.005.100
FR03 7,5A		FR03.075.001	FR03.075.010	FR03.075.100
FR03 10A		FR03.010.001	FR03.010.010	FR03.010.100
FR03 15A		FR03.015.001	FR03.015.010	FR03.015.100

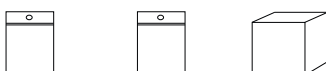
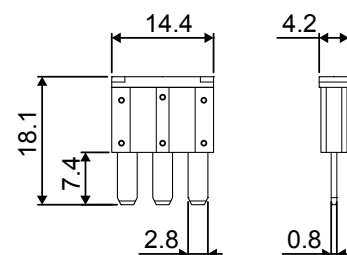

LOW PROFILE MINI BLADE FUSES

FL serie 58V DC

Плоские предохранители Low Profile MINI

Type	Color	Packing unit - order code			
		Упаковка - каталожный номер			
Тип	Цвет	1 pcs / шт.	10 pcs / шт.	50 pcs / шт.	1000 pcs / шт.
FL 2A	Grey	FL00.002.001	FL00.002.010	FL00.002.050	FL00.002.01K
FL 5A	Brown	FL00.005.001	FL00.005.010	FL00.005.050	FL00.005.01K
FL 7,5A	Dark Brown	FL00.075.001	FL00.075.010	FL00.075.050	FL00.075.01K
FL 10A	Red	FL00.010.001	FL00.010.010	FL00.010.050	FL00.010.01K
FL 15A	Blue	FL00.015.001	FL00.015.010	FL00.015.050	FL00.015.01K
FL 20A	Yellow	FL00.020.001	FL00.020.010	FL00.020.050	FL00.020.01K
FL 25A	White	FL00.025.001	FL00.025.010	FL00.025.050	FL00.025.01K
FL 30A	Green	FL00.030.001	FL00.030.010	FL00.030.050	FL00.030.01K

Special type	Packing unit - order code / Упаковка - каталожный номер			
Специальный тип	1 pcs / шт.	10 pcs / шт.	50 pcs / шт.	1000 pcs / шт.
FL01 2A...30A	FL01.0xx.001	FL00.0xx.010	FL00.0xx.050	FL00.0xx.01K

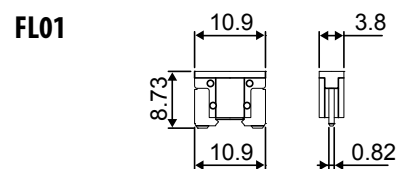
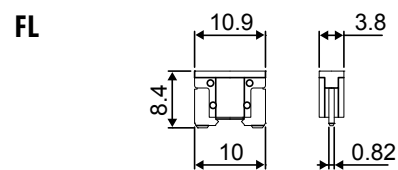

MINI BLADE FUSES

FN serie 32V DC

Плоские предохранители MINI

Type	Color	Packing unit - order code			
		Упаковка - каталожный номер			
Тип	Цвет	1 pcs / шт.	50 pcs / шт.	100 pcs / шт.	1000 pcs / шт.
FN 2A	Grey	FN00.002.001	FN00.002.050	FN00.002.100	FN00.002.01K
FN 3A	Purple	FN00.003.001	FN00.003.050	FN00.003.100	FN00.003.01K
FN 4A	Pink	FN00.004.001	FN00.004.050	FN00.004.100	FN00.004.01K
FN 5A	Brown	FN00.005.001	FN00.005.050	FN00.005.100	FN00.005.01K
FN 7,5A	Dark Brown	FN00.075.001	FN00.075.050	FN00.075.100	FN00.075.01K
FN 10A	Red	FN00.010.001	FN00.050.050	FN00.010.100	FN00.010.01K
FN 15A	Blue	FN00.015.001	FN00.015.050	FN00.015.100	FN00.015.01K
FN 20A	Yellow	FN00.020.001	FN00.020.050	FN00.020.100	FN00.020.01K
FN 25A	White	FN00.025.001	FN00.025.050	FN00.025.100	FN00.025.01K
FN 30A	Green	FN00.030.001	FN00.030.050	FN00.030.100	FN00.030.01K

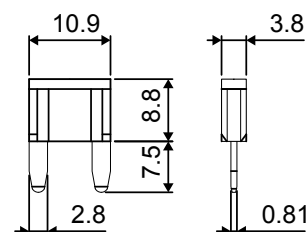

ATO BLADE FUSES
FT serie 32V DC

Плоские предохранители ATO

Type	Color	Packing unit - order code			
		Упаковка - каталожный номер			
Тип	Цвет	1 pcs / шт.	50 pcs / шт.	100 pcs / шт.	2000 pcs / шт.
FT1A	■	FT00.001.001	FT00.001.050	FT00.001.100	FT00.001.02K
FT 2A	■	FT00.002.001	FT00.002.050	FT00.002.100	FT00.002.02K
FT 3A	■	FT00.003.001	FT00.003.050	FT00.003.100	FT00.003.02K
FT 4A	■	FT00.004.001	FT00.004.050	FT00.004.100	FT00.004.02K
FT 5A	■	FT00.005.001	FT00.005.050	FT00.005.100	FT00.005.02K
FT 7,5A	■	FT00.075.001	FT00.075.050	FT00.075.100	FT00.075.02K
FT 10A	■	FT00.010.001	FT00.010.050	FT00.010.100	FT00.010.02K
FT 15A	■	FT00.015.001	FT00.015.050	FT00.015.100	FT00.015.02K
FT 20A	■	FT00.020.001	FT00.020.050	FT00.020.100	FT00.020.02K
FT 25A	□	FT00.025.001	FT00.025.050	FT00.025.100	FT00.025.02K
FT 30A	■	FT00.030.001	FT00.030.050	FT00.030.100	FT00.030.02K
FT 35A	■	FT00.035.001	FT00.035.050	FT00.035.100	FT00.035.02K
FT 40A	■	FT00.040.001	FT00.040.050	FT00.040.100	FT00.040.02K

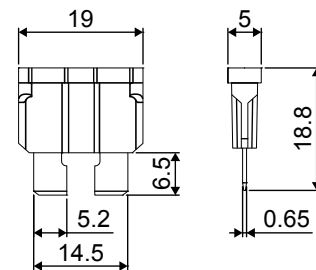
MAXI BLADE FUSES
FX serie 32V DC

Плоские предохранители MAXI

Type	Color	Packing unit - order code		
		Упаковка - каталожный номер		
Тип	Цвет	1 pcs / шт.	10 pcs / шт.	100 pcs / шт.
FX 20A	■	FX00.020.001	FX00.020.010	FX00.020.100
FX 25A	■	FX00.025.001	FX00.025.010	FX00.025.100
FX 30A	■	FX00.030.001	FX00.030.010	FX00.030.100
FX 35A	■	FX00.035.001	FX00.035.010	FX00.035.100
FX 40A	■	FX00.040.001	FX00.040.010	FX00.040.100
FX 50A	■	FX00.050.001	FX00.050.010	FX00.050.100
FX 60A	■	FX00.060.001	FX00.060.010	FX00.060.100
FX 70A	■	FX00.070.001	FX00.070.010	FX00.070.100
FX 80A	□	FX00.080.001	FX00.080.010	FX00.080.100
FX 100A	■	FX00.100.001	FX00.100.010	FX00.100.100

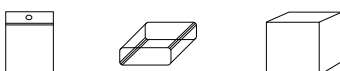
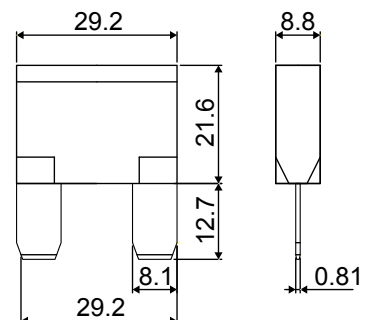

GLOW LOW PROFILE MINI BLADE FUSES

FLL serie 32V DC

Плоские предохранители Low Profile MINI с индикатором LED

Type	Color	Packing unit - order code		
		Упаковка - каталожный номер		
Тип	Цвет	1 pc / шт.	10 pcs / шт.	100 pcs / шт.
FLL 5A		FLL0.005.001	FLL0.005.010	FLL0.005.100
FLL 7,5A		FLL0.075.001	FLL0.075.010	FLL0.075.100
FLL 10A		FLL0.010.001	FLL0.010.010	FLL0.010.100
FLL 15A		FLL0.015.001	FLL0.015.010	FLL0.015.100
FLL 20A		FLL0.020.001	FLL0.020.010	FLL0.020.100
FLL 25A		FLL0.025.001	FLL0.025.010	FLL0.025.100
FLL 30A		FLL0.030.001	FLL0.030.010	FLL0.030.100

GLOW MINI BLADE FUSES

FNL serie 32V DC

Плоские предохранители MINI с индикатором LED

Type	Color	Packing unit - order code		
		Упаковка - каталожный номер		
Тип	Цвет	1 pc / шт.	10 pcs / шт.	100 pcs / шт.
FNL 3A		FNL0.003.001	FNL0.003.010	FNL0.003.100
FNL 5A		FNL0.005.001	FNL0.005.010	FNL0.005.100
FNL 7,5A		FNL0.075.001	FNL0.075.010	FNL0.075.100
FNL 10A		FNL0.010.001	FNL0.010.010	FNL0.010.100
FNL 15A		FNL0.015.001	FNL0.015.010	FNL0.015.100
FNL 20A		FNL0.020.001	FNL0.020.010	FNL0.020.100
FNL 25A		FNL0.025.001	FNL0.025.010	FNL0.025.100
FNL 30A		FNL0.030.001	FNL0.030.010	FNL0.030.100

GLOW ATO BLADE FUSES

Плоские предохранители ATO с индикатором LED

FTL serie 32V DC

Type	Color	Packing unit - order code		
		Упаковка - каталожный номер		
Тип	Цвет	1 pc / шт.	10 pcs / шт.	100 pcs / шт.
FTL 3A		FTL0.003.001	FTL0.003.010	FTL0.003.100
FTL 5A		FTL0.005.001	FTL0.005.010	FTL0.005.100
FTL 7,5A		FTL0.075.001	FTL0.075.010	FTL0.075.100
FTL 10A		FTL0.010.001	FTL0.010.010	FTL0.010.100
FTL 15A		FTL0.015.001	FTL0.015.010	FTL0.015.100
FTL 20A		FTL0.020.001	FTL0.020.010	FTL0.020.100
FTL 25A		FTL0.025.001	FTL0.025.010	FTL0.025.100
FTL 30A		FTL0.030.001	FTL0.030.010	FTL0.030.100
FTL 35A		FTL0.035.001	FTL0.035.010	FTL0.035.100
FTL 40A		FTL0.040.001	FTL0.040.010	FTL0.040.100

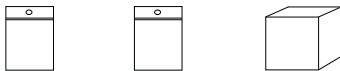
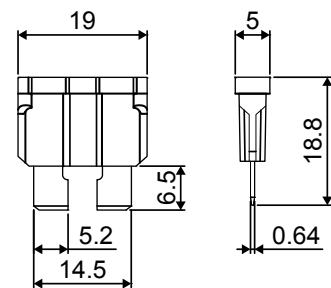
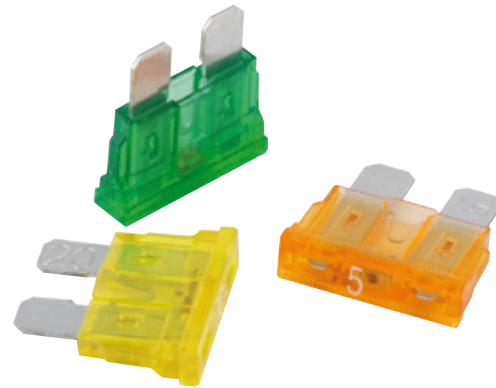

GLOW MAXI BLADE FUSES

Плоские предохранители MAXI с индикатором LED

FXL serie 32V DC

Type	Color	Packing unit - order code		
		Упаковка - каталожный номер		
Тип	Цвет	1 pc / шт.	10 pcs / шт.	100 pcs / шт.
FXL 20A		FXL0.020.001	FXL0.020.010	FXL0.020.100
FXL 30A		FXL0.030.001	FXL0.030.010	FXL0.030.100
FXL 40A		FXL0.040.001	FXL0.040.010	FXL0.040.100
FXL 50A		FXL0.050.001	FXL0.050.010	FXL0.050.100
FXL 60A		FXL0.060.001	FXL0.060.010	FXL0.060.100
FXL 70A		FXL0.070.001	FXL0.070.010	FXL0.070.100
FXL 80A		FXL0.080.001	FXL0.080.010	FXL0.080.100
FXL 100A		FXL0.100.001	FXL0.100.010	FXL0.100.100

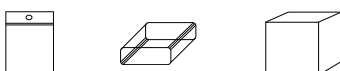
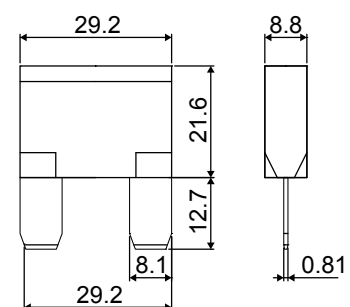
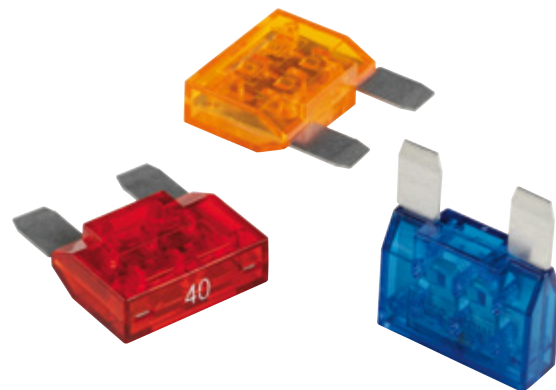

MIDI FUSES

FD serie 32V DC

Предохранители MIDI

Type	Color	Packing unit - order code		
Тип	Цвет	Упаковка - каталожный номер		
		1 pc / шт.	10 pcs / шт.	100 pcs / шт.
FD 30A	Orange	FD00.030.001	FD00.030.010	FD00.030.100
FD 40A	Green	FD00.040.001	FD00.040.010	FD00.040.100
FD 50A	Red	FD00.050.001	FD00.050.010	FD00.050.100
FD 60A	Yellow	FD00.060.001	FD00.060.010	FD00.060.100
FD 70A	Orange	FD00.070.001	FD00.070.010	FD00.070.100
FD 80A	White	FD00.080.001	FD00.080.010	FD00.080.100
FD 100A	Blue	FD00.100.001	FD00.100.010	FD00.100.100
FD 125A	Pink	FD00.125.001	FD00.125.010	FD00.125.100
FD 150A	Grey	FD00.150.001	FD00.150.010	FD00.150.100
FD 200A	Purple	FD00.200.001	FD00.200.010	FD00.200.100

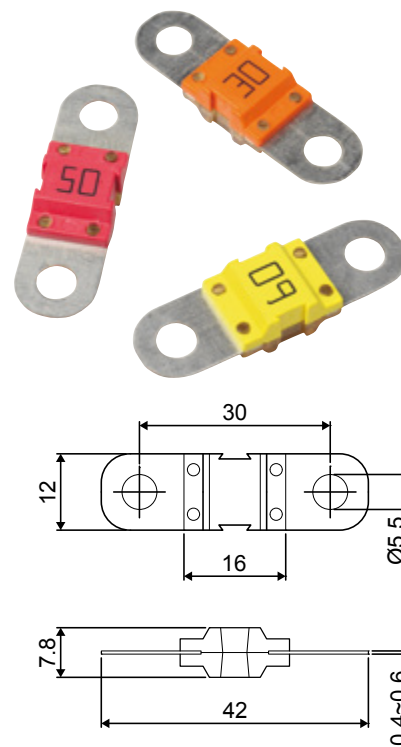

MEGA FUSES

FG serie 32V DC

Предохранители MEGA

Type	Color	Packing unit - order code		
Тип	Цвет	Упаковка - каталожный номер		
		1 pc / шт.	10 pcs / шт.	100 pcs / шт.
FG 40A	Black	FG00.040.001	FG00.040.010	FG00.040.100
FG 60A	Black	FG00.060.001	FG00.060.010	FG00.060.100
FG 80A	Red	FG00.080.001	FG00.080.010	FG00.080.100
FG 100A	Yellow	FG00.100.001	FG00.100.010	FG00.100.100
FG 125A	Green	FG00.125.001	FG00.125.010	FG00.125.100
FG 150A	Orange	FG00.150.001	FG00.150.010	FG00.150.100
FG 175A	White	FG00.175.001	FG00.175.010	FG00.175.100
FG 200A	Blue	FG00.200.001	FG00.200.010	FG00.200.100
FG 225A	Orange	FG00.225.001	FG00.225.010	FG00.225.100
FG 250A	Pink	FG00.250.001	FG00.250.010	FG00.250.100
FG 300A	Grey	FG00.300.001	FG00.300.010	FG00.300.100
FG 350A	Green	FG00.350.001	FG00.350.010	FG00.350.100
FG 400A	Purple	FG00.400.001	FG00.400.010	FG00.400.100
FG 450A	Brown	FG00.450.001	FG00.450.010	FG00.450.100
FG 500A	Brown	FG00.500.001	FG00.500.010	FG00.500.100

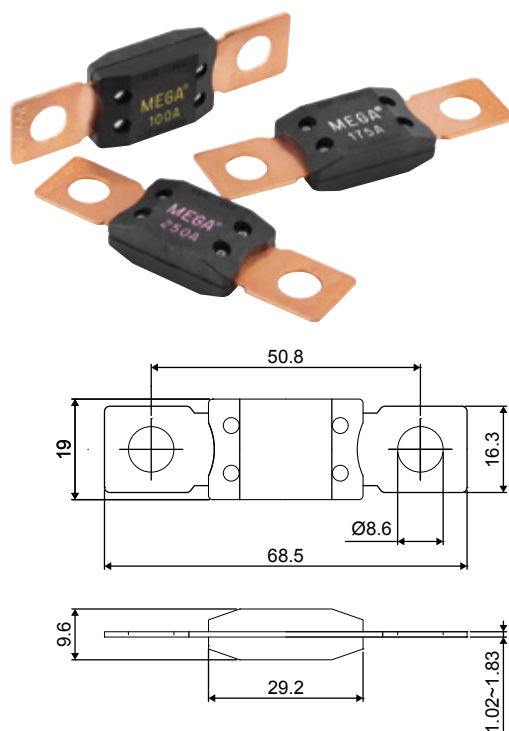

MAIN FUSES (BATTERY CLAMP)
FM serie 58V DC

Компактные предохранители

Type	Packing unit - order code	
	Упаковка - каталожный номер	
Тип	1 pc / шт.	100 pcs / шт.
FM 50A	FM00.050.001	FM00.050.100
FM 75A	FM00.075.001	FM00.075.100
FM 100A	FM00.100.001	FM00.100.100
FM 125A	FM00.125.001	FM00.125.100
FM 150A	FM00.150.001	FM00.150.100
FM 175A	FM00.175.001	FM00.175.100
FM 200A	FM00.200.001	FM00.200.100
FM 250A	FM00.250.001	FM00.250.100
FM 300A	FM00.300.001	FM00.300.100

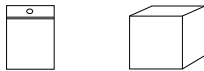
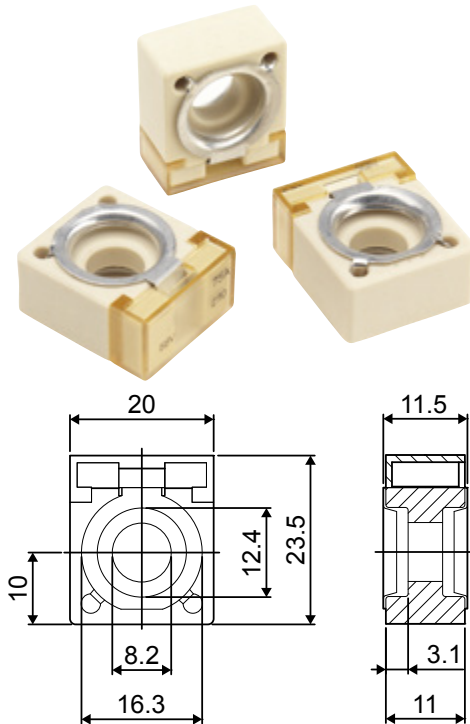
STRIP FUSES
FS serie 32V DC

Ленточные предохранители

Type	Packing unit - order code		
	Упаковка - каталожный номер		
Тип	1 pc / шт.	10 pcs / шт.	100 pcs / шт.
FS 30A	FS00.030.001	FS00.030.010	FS00.030.100
FS 40A	FS00.040.001	FS00.040.010	FS00.040.100
FS 50A	FS00.050.001	FS00.050.010	FS00.050.100
FS 60A	FS00.060.001	FS00.060.010	FS00.060.100
FS 80A	FS00.080.001	FS00.080.010	FS00.080.100
FS 110A	FS00.110.001	FS00.110.010	FS00.110.100
FS 150A	FS00.150.001	FS00.150.010	FS00.150.100
FS 175A	FS00.175.001	FS00.175.010	FS00.175.100

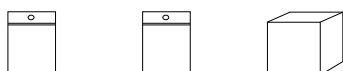
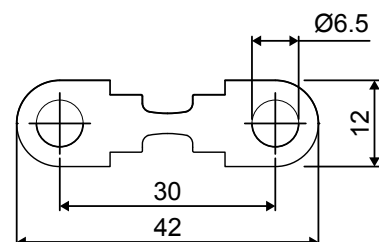

STRIP FUSES

FS1 serie 36V DC

Ленточные предохранители

Type Тип	Packing unit - order code Упаковка - каталожный номер		
	1 pc / шт.	10 pcs / шт.	100 pcs / шт.
FS1 25A	FS01.025.001	FS01.025.010	FS01.025.100
FS1 30A	FS01.030.001	FS01.030.010	FS01.030.100
FS1 40A	FS01.040.001	FS01.040.010	FS01.040.100
FS1 50A	FS01.050.001	FS01.050.010	FS01.050.100
FS1 60A	FS01.060.001	FS01.060.010	FS01.060.100
FS1 70A	FS01.070.001	FS01.070.010	FS01.070.100
FS1 80A	FS01.080.001	FS01.080.010	FS01.080.100
FS1 100A	FS01.100.001	FS01.100.010	FS01.100.100
FS1 120A	FS01.120.001	FS01.120.010	FS01.120.100
FS1 125A	FS01.125.001	FS01.125.010	FS01.125.100
FS1 150A	FS01.150.001	FS01.150.010	FS01.150.100

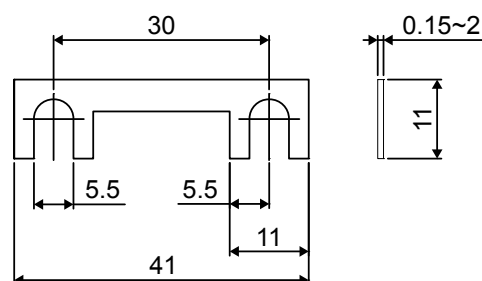
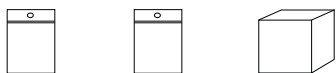

STRIP FUSES (HOUSING)

FS1H serie 80V DC

Ленточные предохранители (с изолятором)

Type Тип	Packing unit - order code Упаковка - каталожный номер		
	1 pc / шт.	10 pcs / шт.	50 pcs / шт.
FS1H 30A	FS1H.030.001	FS1H.030.010	FS1H.030.050
FS1H 40A	FS1H.040.001	FS1H.040.010	FS1H.040.050
FS1H 50A	FS1H.050.001	FS1H.050.010	FS1H.050.050
FS1H 60A	FS1H.060.001	FS1H.060.010	FS1H.060.050
FS1H 70A	FS1H.070.001	FS1H.070.010	FS1H.070.050
FS1H 80A	FS1H.080.001	FS1H.080.010	FS1H.080.050
FS1H 100A	FS1H.100.001	FS1H.100.010	FS1H.050.050
FS1H 120A	FS1H.120.001	FS1H.120.010	FS1H.120.050
FS1H 125A	FS1H.125.001	FS1H.125.010	FS1H.125.050
FS1H 150A	FS1H.150.001	FS1H.150.010	FS1H.150.050

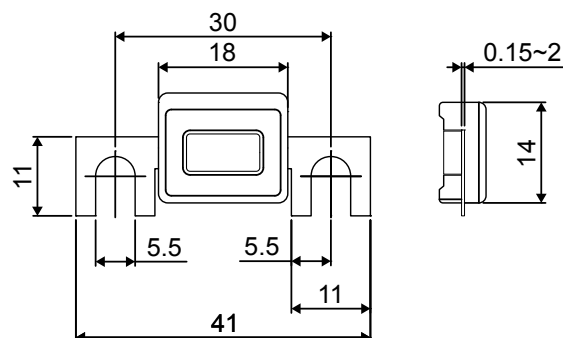
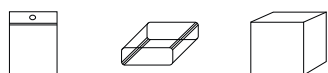

STRIP FUSES FOR BATTERY POWERED VEHICLES
FS2 serie 80V DC

Ленточные предохранители для электромобилей

Type	Packing unit - order code		
	Упаковка - каталожный номер		
Тип	1 pc / шт.	5 pcs / шт.	50 pcs / шт.
FS2 35A	FS02.035.001	FS02.035.005	FS02.035.050
FS2 40A	FS02.040.001	FS02.040.005	FS02.040.050
FS2 50A	FS02.050.001	FS02.050.005	FS02.050.050
FS2 63A	FS02.063.001	FS02.063.005	FS02.063.050
FS2 80A	FS02.080.001	FS02.080.005	FS02.080.050
FS2 100A	FS02.100.001	FS02.100.005	FS02.100.050
FS2 125A	FS02.125.001	FS02.125.005	FS02.125.050
FS2 130A	FS02.130.001	FS02.130.005	FS02.130.050
FS2 135A	FS02.135.001	FS02.135.005	FS02.135.050
FS2 150A	FS02.150.001	FS02.150.005	FS02.150.050
FS2 160A	FS02.160.001	FS02.160.005	FS02.160.050
FS2 175A	FS02.175.001	FS02.175.005	FS02.175.050
FS2 200A	FS02.200.001	FS02.200.005	FS02.200.050
FS2 225A	FS02.225.001	FS02.225.005	FS02.225.050
FS2 250A	FS02.250.001	FS02.250.005	FS02.250.050
FS2 275A	FS02.275.001	FS02.275.005	FS02.275.050
FS2 300A	FS02.300.001	FS02.300.005	FS02.300.050
FS2 325A	FS02.325.001	FS02.325.005	FS02.325.050
FS2 355A	FS02.355.001	FS02.355.005	FS02.355.050
FS2 400A	FS02.400.001	FS02.400.005	FS02.400.050
FS2 425A	FS02.425.001	FS02.425.005	FS02.425.050
FS2 500A	FS02.500.001	FS02.500.005	FS02.500.050

STRIP FUSES (HOUSING) FOR BATTERY POWERED VEHICLES

FS2H serie 80V DC

Ленточные предохранители (с изолятором) для электромобилей

Type	Packing unit - order code		
	Упаковка - каталожный номер		
Тип	1 pc / шт.	5 pcs / шт.	50 pcs / шт.
FS2H 35A	FS2H.035.001	FS2H.035.005	FS2H.035.050
FS2H 40A	FS2H.040.001	FS2H.040.005	FS2H.040.050
FS2H 50A	FS2H.050.001	FS2H.050.005	FS2H.050.050
FS2H 63A	FS2H.063.001	FS2H.063.005	FS2H.063.050
FS2H 80A	FS2H.080.001	FS2H.080.005	FS2H.080.050
FS2H 100A	FS2H.100.001	FS2H.100.005	FS2H.100.050
FS2H 125A	FS2H.125.001	FS2H.125.005	FS2H.125.050
FS2H 130A	FS2H.130.001	FS2H.130.005	FS2H.130.050
FS2H 135A	FS2H.135.001	FS2H.135.005	FS2H.135.050
FS2H 150A	FS2H.150.001	FS2H.150.005	FS2H.150.050
FS2H 160A	FS2H.160.001	FS2H.160.005	FS2H.160.050
FS2H 175A	FS2H.175.001	FS2H.175.005	FS2H.175.050
FS2H 200A	FS2H.200.001	FS2H.200.005	FS2H.200.050
FS2H 225A	FS2H.225.001	FS2H.225.005	FS2H.225.050
FS2H 250A	FS2H.250.001	FS2H.250.005	FS2H.250.050
FS2H 275A	FS2H.275.001	FS2H.275.005	FS2H.275.050
FS2H 300A	FS2H.300.001	FS2H.300.005	FS2H.300.050
FS2H 325A	FS2H.325.001	FS2H.325.005	FS2H.325.050
FS2H 355A	FS2H.355.001	FS2H.355.005	FS2H.355.050
FS2H 400A	FS2H.400.001	FS2H.400.005	FS2H.400.050
FS2H 425A	FS2H.425.001	FS2H.425.005	FS2H.425.050
FS2H 500A	FS2H.500.001	FS2H.500.005	FS2H.500.050

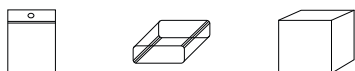
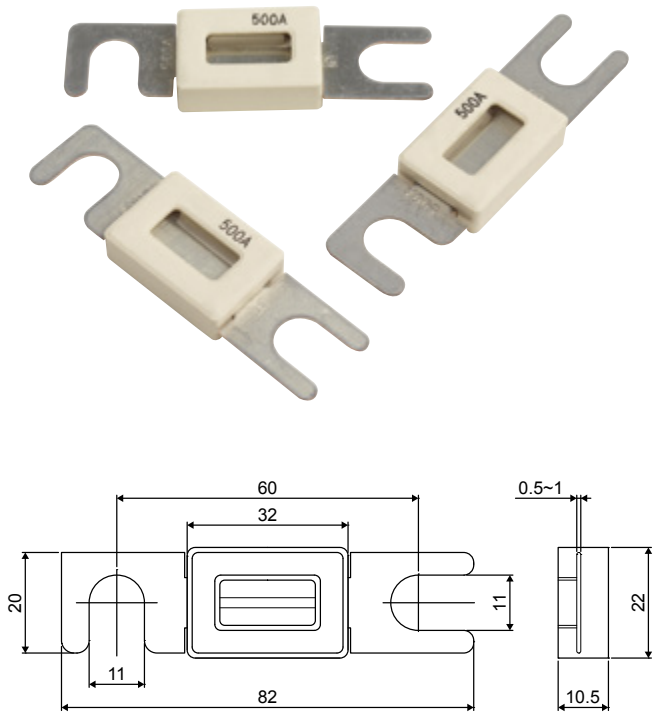

CARTRIDGE FUSES
FJ07 serie 32V DC

Предохранители картриджного типа

Type	Color	Packing unit - order code		
		Упаковка - каталожный номер		
Тип	Цвет	1 pc / шт.	5 pcs / шт.	100 pcs / шт.
FJ07 20A		FJ07.020.001	FJ07.020.005	FJ07.020.100
FJ07 25A		FJ07.025.001	FJ07.025.005	FJ07.025.100
FJ07 30A		FJ07.030.001	FJ07.030.005	FJ07.030.100
FJ07 40A		FJ07.040.001	FJ07.040.005	FJ07.040.100
FJ07 50A		FJ07.050.001	FJ07.050.005	FJ07.050.100
FJ07 60A		FJ07.060.001	FJ07.060.005	FJ07.060.100
FJ07 70A		FJ07.070.001	FJ07.070.005	FJ07.070.100
FJ07 80A		FJ07.080.001	FJ07.080.005	FJ07.080.100
FJ07 100A		FJ07.100.001	FJ07.100.005	FJ07.100.100

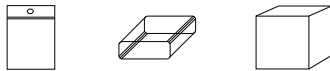
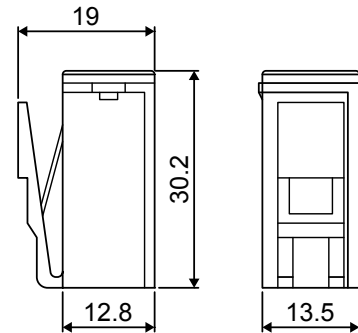
CARTRIDGE FUSES
FJ08 serie 32V DC

Предохранители картриджного типа

Type	Color	Packing unit - order code		
		Упаковка - каталожный номер		
Тип	Цвет	1 pc / шт.	5 pcs / шт.	100 pcs / шт.
FJ08 20A		FJ08.020.001	FJ08.020.005	FJ08.020.100
FJ08 30A		FJ08.030.001	FJ08.030.005	FJ08.030.100
FJ08 40A		FJ08.040.001	FJ08.040.005	FJ08.040.100
FJ08 50A		FJ08.050.001	FJ08.050.005	FJ08.050.100
FJ08 60A		FJ08.060.001	FJ08.060.005	FJ08.060.100
FJ08 70A		FJ08.070.001	FJ08.070.005	FJ08.070.100
FJ08 80A		FJ08.080.001	FJ08.080.005	FJ08.080.100
FJ08 100A		FJ08.100.001	FJ08.100.005	FJ08.100.100
FJ08 120A		FJ08.120.001	FJ08.120.005	FJ08.120.100

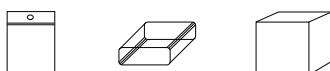
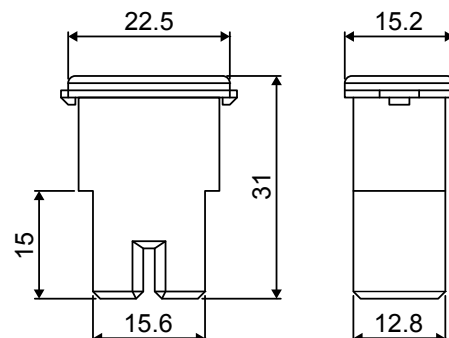

CARTRIDGE FUSES

FJ09 serie 32V DC

Предохранители картриджного типа

Type	Color	Packing unit - order code		
		Упаковка - каталожный номер		
Тип	Цвет	1 pcs / шт.	5 pcs / шт.	100 pcs / шт.
FJ09 45A	■	FJ09.045.001	FJ09.045.005	FJ09.045.100
FJ09 65A	■	FJ09.065.001	FJ09.065.005	FJ09.065.100
FJ09 75A	■	FJ09.075.001	FJ09.075.005	FJ09.075.100

CARTRIDGE FUSES

FJ10 serie 32V DC

Предохранители картриджного типа

Type	Color	Packing unit - order code		
		Упаковка - каталожный номер		
Тип	Цвет	1 pcs / шт.	5 pcs / шт.	100 pcs / шт.
FJ10 20A	■	FJ10.020.001	FJ10.020.005	FJ10.020.100
FJ10 30A	■	FJ10.030.001	FJ10.030.005	FJ10.030.100
FJ10 40A	■	FJ10.040.001	FJ10.040.005	FJ10.040.100
FJ10 50A	■	FJ10.050.001	FJ10.050.005	FJ10.050.100
FJ10 60A	■	FJ10.060.001	FJ10.060.005	FJ10.060.100
FJ10 70A	■	FJ10.070.001	FJ10.070.005	FJ10.070.100
FJ10 80A	■	FJ10.080.001	FJ10.080.005	FJ10.080.100
FJ10 100A	■	FJ10.100.001	FJ10.100.005	FJ10.100.100

CARTRIDGE FUSES
FJ11 serie 32V DC

Предохранители картриджного типа

Type	Color	Packing unit - order code		
		Упаковка - каталожный номер		
Тип	Цвет	1 pcs / шт.	5 pcs / шт.	100 pcs / шт.
FJ11 20A		FJ11.020.001	FJ11.020.005	FJ11.020.100
FJ11 30A		FJ11.030.001	FJ11.030.005	FJ11.030.100
FJ11 40A		FJ11.040.001	FJ11.040.005	FJ11.040.100
FJ11 50A		FJ11.050.001	FJ11.050.005	FJ11.050.100
FJ11 60A		FJ11.060.001	FJ11.060.005	FJ11.060.100
FJ11 70A		FJ11.070.001	FJ11.070.005	FJ11.070.100
FJ11 80A		FJ11.080.001	FJ11.080.005	FJ11.080.100
FJ11 100A		FJ11.100.001	FJ11.100.005	FJ11.100.100
FJ11 120A		FJ11.120.001	FJ11.120.005	FJ11.120.100

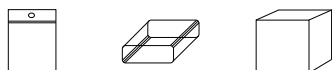
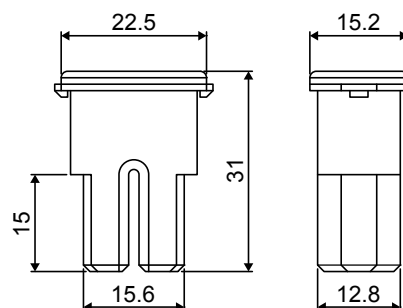
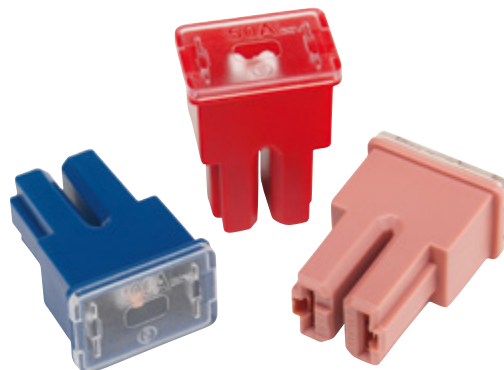
CARTRIDGE FUSES
FJ12 serie 32V DC

Предохранители картриджного типа

Type	Color	Packing unit - order code		
		Упаковка - каталожный номер		
Тип	Цвет	1 pcs / шт.	5 pcs / шт.	100 pcs / шт.
FJ12 20A		FJ12.020.001	FJ12.020.005	FJ12.020.100
FJ12 30A		FJ12.030.001	FJ12.030.005	FJ12.030.100
FJ12 40A		FJ12.040.001	FJ12.040.005	FJ12.040.100
FJ12 50A		FJ12.050.001	FJ12.050.005	FJ12.050.100
FJ12 60A		FJ12.060.001	FJ12.060.005	FJ12.060.100
FJ12 70A		FJ12.070.001	FJ12.070.005	FJ12.070.100
FJ12 80A		FJ12.080.001	FJ12.080.005	FJ12.080.100
FJ12 100A		FJ12.100.001	FJ12.100.005	FJ12.100.100
FJ12 120A		FJ12.120.001	FJ12.120.005	FJ12.120.100
FJ12 140A		FJ12.140.001	FJ12.140.005	FJ12.140.100

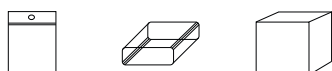
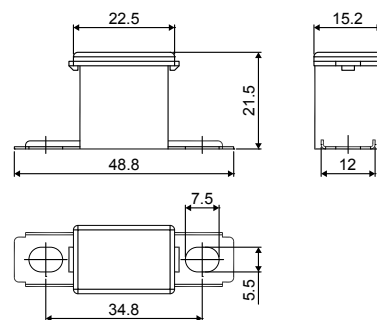
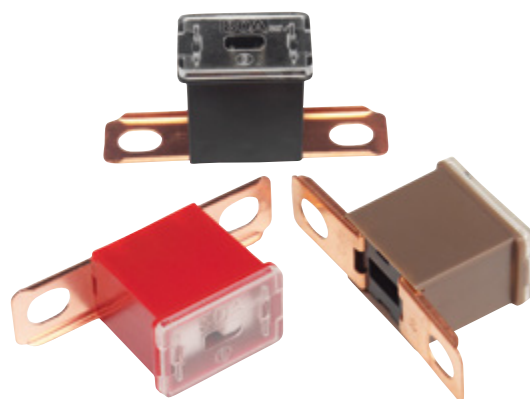

CARTRIDGE FUSES

FJ13 serie 32V DC

Предохранители картриджного типа

Type	Color	Packing unit - order code		
		Упаковка - каталожный номер		
Тип	Цвет	1 pcs / шт.	5 pcs / шт.	100 pcs / шт.
FJ13 20A		FJ13.020.001	FJ13.020.005	FJ13.020.100
FJ13 30A		FJ13.030.001	FJ13.030.005	FJ13.030.100
FJ13 40A		FJ13.040.001	FJ13.040.005	FJ13.040.100
FJ13 50A		FJ13.050.001	FJ13.050.005	FJ13.050.100
FJ13 60A		FJ13.060.001	FJ13.060.005	FJ13.060.100
FJ13 70A		FJ13.070.001	FJ13.070.005	FJ13.070.100
FJ13 80A		FJ13.080.001	FJ13.080.005	FJ13.080.100
FJ13 100A		FJ13.100.001	FJ13.100.005	FJ13.100.100
FJ13 120A		FJ13.120.001	FJ13.120.005	FJ13.120.100
FJ13 140A		FJ13.140.001	FJ13.140.005	FJ13.140.100

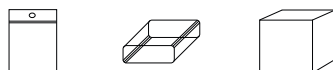
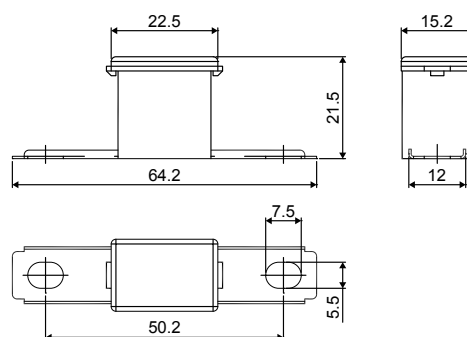
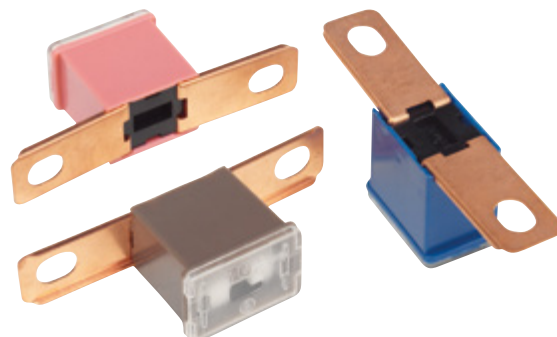

CARTRIDGE FUSES

FJ14 serie 32V DC

Предохранители картриджного типа

Type	Color	Packing unit - order code		
		Упаковка - каталожный номер		
Тип	Цвет	1 pcs / шт.	5 pcs / шт.	100 pcs / шт.
FJ14 20A		FJ14.020.001	FJ14.020.005	FJ14.020.100
FJ14 30A		FJ14.030.001	FJ14.030.005	FJ14.030.100
FJ14 40A		FJ14.040.001	FJ14.040.005	FJ14.040.100
FJ14 50A		FJ14.050.001	FJ14.050.005	FJ14.050.100
FJ14 60A		FJ14.060.001	FJ14.060.005	FJ14.060.100
FJ14 70A		FJ14.070.001	FJ14.070.005	FJ14.070.100
FJ14 80A		FJ14.080.001	FJ14.080.005	FJ14.080.100
FJ14 100A		FJ14.100.001	FJ14.100.005	FJ14.100.100
FJ14 120A		FJ14.120.001	FJ14.120.005	FJ14.120.100

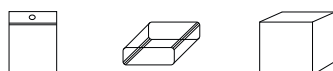
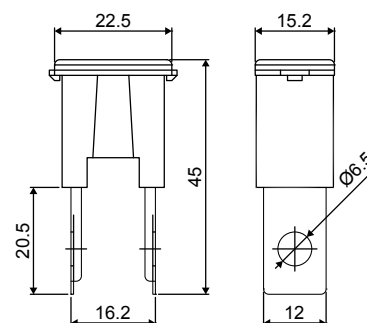
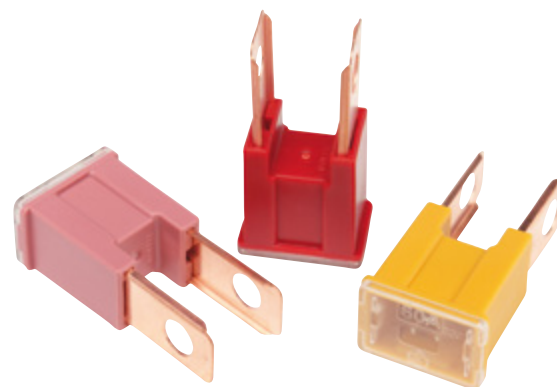

CARTRIDGE FUSES
FJ15 serie 32V DC

Предохранители картриджного типа

Type	Color	Packing unit - order code		
		Упаковка - каталожный номер		
Тип	Цвет	1 pc / шт.	5 pcs / шт.	100 pcs / шт.
FJ15 20A		FJ15.020.001	FJ15.020.005	FJ15.020.100
FJ15 30A		FJ15.030.001	FJ15.030.005	FJ15.030.100
FJ15 40A		FJ15.040.001	FJ15.040.005	FJ15.040.100
FJ15 50A		FJ15.050.001	FJ15.050.005	FJ15.050.100
FJ15 60A		FJ15.060.001	FJ15.060.005	FJ15.060.100
FJ15 70A		FJ15.070.001	FJ15.070.005	FJ15.070.100
FJ15 80A		FJ15.080.001	FJ15.080.005	FJ15.080.100
FJ15 100A		FJ15.100.001	FJ15.100.005	FJ15.100.100
FJ15 120A		FJ15.120.001	FJ15.120.005	FJ15.120.100

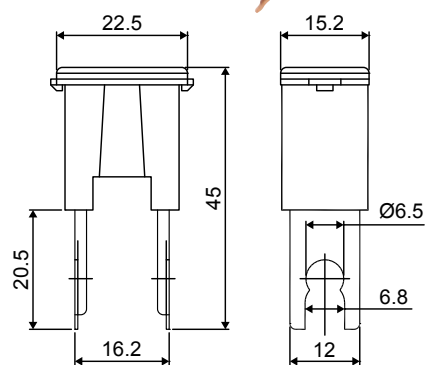
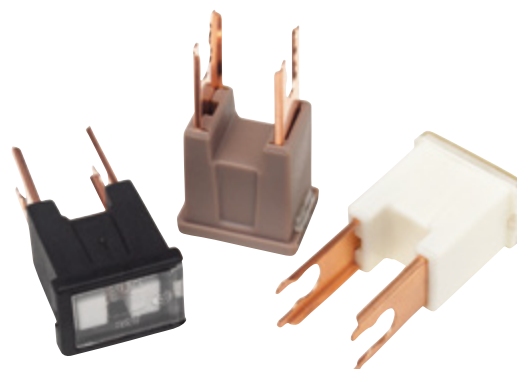

CARTRIDGE FUSES

FJ16 serie 32V DC

Предохранители картриджного типа

Type	Color	Packing unit - order code		
		Упаковка - каталожный номер		
Тип	Цвет	1 pcs / шт.	5 pcs / шт.	100 pcs / шт.
FJ16 20A		FJ16.020.001	FJ16.020.005	FJ16.020.100
FJ16 25A		FJ16.025.001	FJ16.025.005	FJ16.025.100
FJ16 30A		FJ16.030.001	FJ16.030.005	FJ16.030.100
FJ16 40A		FJ16.040.001	FJ16.040.005	FJ16.040.100
FJ16 50A		FJ16.050.001	FJ16.050.005	FJ16.050.100
FJ16 60A		FJ16.060.001	FJ16.060.005	FJ16.060.100
FJ16 70A		FJ16.070.001	FJ16.070.005	FJ16.070.100
FJ16 80A		FJ16.080.001	FJ16.080.005	FJ16.080.100

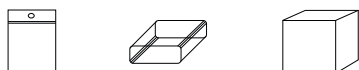
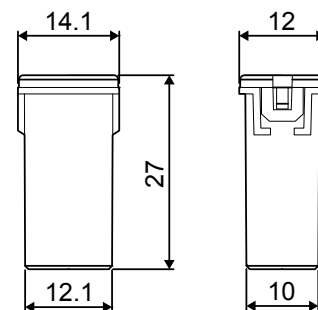

CARTRIDGE FUSES

FJ17 serie 58V DC

Предохранители картриджного типа

Type	Color	Packing unit - order code		
		Упаковка - каталожный номер		
Тип	Цвет	1 pcs / шт.	5 pcs / шт.	100 pcs / шт.
FJ17 20A		FJ17.020.001	FJ17.020.005	FJ17.020.100
FJ17 25A		FJ17.025.001	FJ17.025.005	FJ17.025.100
FJ17 30A		FJ17.030.001	FJ17.030.005	FJ17.030.100
FJ17 40A		FJ17.040.001	FJ17.040.005	FJ17.040.100
FJ17 50A		FJ17.050.001	FJ17.050.005	FJ17.050.100
FJ17 60A		FJ17.060.001	FJ17.060.005	FJ17.060.100

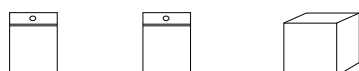
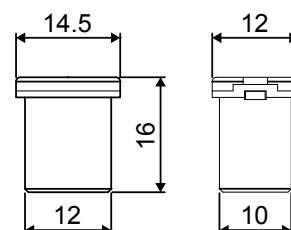

CARTRIDGE FUSES
FJ18 serie 32V DC

Предохранители картриджного типа

Type	Color	Packing unit - order code		
		Упаковка - каталожный номер		
Тип	Цвет	1 pc / шт.	5 pcs / шт.	100 pcs / шт.
FJ18 15A	■	FJ18.015.001	FJ18.015.005	FJ18.015.100
FJ18 20A	■	FJ18.020.001	FJ18.020.005	FJ18.020.100
FJ18 25A	□	FJ18.025.001	FJ18.025.005	FJ18.025.100
FJ18 30A	■	FJ18.030.001	FJ18.030.005	FJ18.030.100
FJ18 40A	■	FJ18.040.001	FJ18.040.005	FJ18.040.100

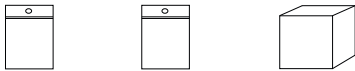
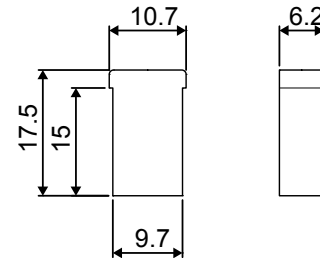
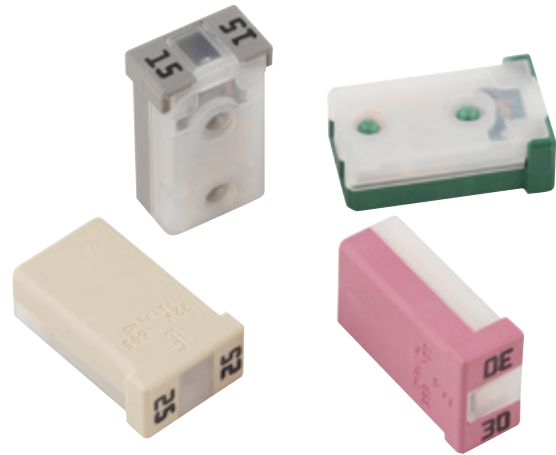
CARTRIDGE FUSES
FJ19 serie 32V DC

Предохранители картриджного типа

Type	Color	Packing unit - order code		
		Упаковка - каталожный номер		
Тип	Цвет	1 pc / шт.	5 pcs / шт.	100 pcs / шт.
FJ19 15A	■	FJ19.015.001	FJ19.015.005	FJ19.015.100
FJ19 20A	■	FJ19.020.001	FJ19.020.005	FJ19.020.100
FJ19 25A	□	FJ19.025.001	FJ19.025.005	FJ19.025.100
FJ19 30A	■	FJ19.030.001	FJ19.030.005	FJ19.030.100
FJ19 40A	■	FJ19.040.001	FJ19.040.005	FJ19.040.100

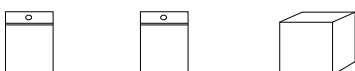
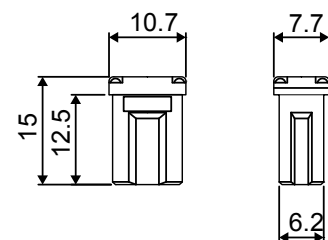

CONTINENTAL FUSES (TORPEDO)

FC serie 32V DC

Предохранители торпедо

Type	Color	Packing unit - order code		
		Упаковка - каталожный номер		
Тип	Цвет	1 pc / шт.	100 pcs / шт.	2000 pcs / шт.
FC 5A		FC00.005.001	FC00.005.100	FC00.005.02K
FC 8A		FC00.008.001	FC00.008.100	FC00.008.02K
FC 16A		FC00.016.001	FC00.016.100	FC00.016.02K
FC 25A		FC00.025.001	FC00.025.100	FC00.025.02K

GLASS FUSES FAST-ACTING

FGL1 serie 250V

Стеклянные предохранители быстродействующие

Type	Packing unit - order code		
	Упаковка - каталожный номер		
Тип	1 pc / шт.	10 pcs / шт.	100 pcs / шт.
FGL1 0,5A	FGL1.050.001	FGL1.050.010	FGL1.050.100
FGL1 0,63A	FGL1.063.001	FGL1.063.010	FGL1.063.100
FGL1 0,8A	FGL1.080.001	FGL1.080.010	FGL1.080.100
FGL1 1A	FGL1.010.001	FGL1.010.010	FGL1.010.100
FGL1 1,25A	FGL1.125.001	FGL1.125.010	FGL1.125.100
FGL1 1,6A	FGL1.160.001	FGL1.160.010	FGL1.160.100
FGL1 2A	FGL1.200.001	FGL1.200.010	FGL1.200.100
FGL1 2,5A	FGL1.250.001	FGL1.250.010	FGL1.250.100
FGL1 3,15A	FGL1.315.001	FGL1.315.010	FGL1.315.100
FGL1 4A	FGL1.400.001	FGL1.400.010	FGL1.400.100
FGL1 5A	FGL1.500.001	FGL1.500.010	FGL1.500.100
FGL1 6,3A	FGL1.630.001	FGL1.630.010	FGL1.630.100
FGL1 8A	FGL1.800.001	FGL1.800.010	FGL1.800.100
FGL1 10A	FGL1.100.001	FGL1.100.010	FGL1.100.100

GLASS FUSES TIME-LAG

Стеклянные предохранители

FGL2 serie 250V

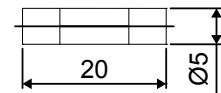
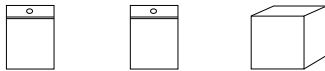

Type Тип	Packing unit - order code Упаковка - каталожный номер		
	1 pcs / шт.	10 pcs / шт.	100 pcs / шт.
FGL2 0,5A	FGL2.050.001	FGL2.050.010	FGL2.050.100
FGL2 0,63A	FGL2.063.001	FGL2.063.010	FGL2.063.100
FGL2 0,8A	FGL2.080.001	FGL2.080.010	FGL2.080.100
FGL2 1A	FGL2.010.001	FGL2.010.010	FGL2.010.100
FGL2 1,25A	FGL2.125.001	FGL2.125.010	FGL2.125.100
FGL2 1,6A	FGL2.160.001	FGL2.160.010	FGL2.160.100
FGL2 2A	FGL2.200.001	FGL2.200.010	FGL2.200.100
FGL2 2,5A	FGL2.250.001	FGL2.250.010	FGL2.250.100
FGL2 3,15A	FGL2.315.001	FGL2.315.010	FGL2.315.100
FGL2 4A	FGL2.400.001	FGL2.400.010	FGL2.400.100
FGL2 5A	FGL2.500.001	FGL2.500.010	FGL2.500.100
FGL2 6,3A	FGL2.630.001	FGL2.630.010	FGL2.630.100
FGL2 8A	FGL2.800.001	FGL2.800.010	FGL2.800.100
FGL2 10A	FGL2.100.001	FGL2.100.010	FGL2.100.100

GLASS FUSES

Стеклянные предохранители

FGL3 serie 32V / 250V

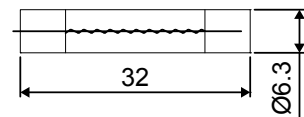
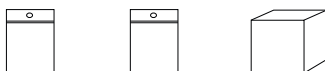
Type Тип	V	Packing unit - order code Упаковка - каталожный номер		
		1 pcs / шт.	10 pcs / шт.	100 pcs / шт.
FGL3 5A	250	FGL3.500.001	FGL3.500.010	FGL3.500.100
FGL3 10A	250	FGL3.100.001	FGL3.100.010	FGL3.100.100
FGL3 15A	32	FGL3.150.001	FGL3.150.010	FGL3.150.100
FGL3 20A	32	FGL3.200.001	FGL3.200.010	FGL3.200.100
FGL3 25A	32	FGL3.250.001	FGL3.250.010	FGL3.250.100
FGL3 30A	32	FGL3.300.001	FGL3.300.010	FGL3.300.100
FGL3 35A	32	FGL3.350.001	FGL3.350.010	FGL3.350.100



LOW PROFILE MINI BLADE FUSES

F115, F117

Комплекты предохранителей Low Profile MINI – упаковка блистер

Order code / Каталогный номер

F115.000.000



Type / Тип	pcs / шт.
FL 5A	1
FL 7,5A	2
FL 10A	2
FL 15A	2
FL 20A	2
FL 25A	2
FL 30A	1

(140 x 80 x 5 mm)

Order code / Каталогный номер

F117.000.000



Type / Тип	pcs / шт.
FL 5A	1
FL 7,5A	2
FL 10A	2
FL 15A	2
FL 20A	2
FL 25A	2
FL 30A	1

puller / пинцет

(160 x 80 x 8 mm)

MINI BLADE FUSES

F113, F116

Комплекты предохранителей MINI – упаковка блистер

Order code / Каталогный номер

F113.000.000



Type / Тип	pcs / шт.
FN 5A	1
FN 7,5A	2
FN 10A	2
FN 15A	2
FN 20A	2
FN 25A	2
FN 30A	1

(140 x 80 x 5 mm)

Order code / Каталогный номер

F116.000.000



Type / Тип	pcs / шт.
FN 5A	1
FN 7,5A	2
FN 10A	2
FN 15A	2
FN 20A	2
FN 25A	2
FN 30A	1

puller / пинцет

(160 x 80 x 8 mm)

ATO BLADE FUSES

Комплекты предохранителей АТО – упаковка блистер

Order code / Каталогный номер

F214.000.000



Type / Тип	pcs / шт.
FT 5A	1
FT 7,5A	1
FT 10A	1
FT 15A	2
FT 20A	2
FT 25A	2
FT 30A	2
FT 40A	1

(140 x 80 x 5 mm)

F214, F222

Order code / Каталогный номер

F222.000.000



Type / Тип	pcs / шт.
FT 5A	1
FT 7,5A	1
FT 10A	1
FT 15A	1
FT 20A	1
FT 25A	1

puller / пинцет

(160 x 80 x 8 mm)

ATO BLADE FUSES

Комплекты предохранителей АТО – упаковка блистер

Order code / Каталогный номер

F224.000.000



Type / Тип	pcs / шт.
FT 5A	1
FT 7,5A	1
FT 10A	1
FT 15A	2
FT 20A	2
FT 25A	2
FT 30A	2
FT 40A	1

puller / пинцет

(160 x 80 x 8 mm)

F224, F261

Order code / Каталогный номер

F261.000.000



MINI, ATO, STRIP FUSES



Type / Тип	pcs / шт.
FN 5A	2
FN 7,5A	1
FN 10A	2
FN 15A	1
FT 10A	3
FT 15A	2
FT 20A	1
FT 25A	1
FT 30A	1
FS 30A	1
FS 50A	1
FS 110A	1
FS 150A	1

(160 x 80 x 8 mm)

GLOW BLADE FUSES

F130, F131, F132



Комплекты плоских предохранителей с индикатором LED – упаковка блистер

Order code / Каталогный номер		Order code / Каталогный номер		Order code / Каталогный номер																																																	
F132.000.000	GLOW Low profile MINI	F130.000.000	GLOW MINI	F131.000.000	GLOW ATO																																																
	<table border="1"> <thead> <tr> <th>Type / Тип</th> <th>pcs шт.</th> </tr> </thead> <tbody> <tr><td>FLL 5A</td><td>1</td></tr> <tr><td>FLL 7,5A</td><td>2</td></tr> <tr><td>FLL 10A</td><td>2</td></tr> <tr><td>FLL 15A</td><td>2</td></tr> <tr><td>FLL 20A</td><td>2</td></tr> <tr><td>FLL 25A</td><td>2</td></tr> <tr><td>FLL 30A</td><td>1</td></tr> </tbody> </table> <p>(140 x 80 x 5 mm)</p>	Type / Тип	pcs шт.	FLL 5A	1	FLL 7,5A	2	FLL 10A	2	FLL 15A	2	FLL 20A	2	FLL 25A	2	FLL 30A	1		<table border="1"> <thead> <tr> <th>Type / Тип</th> <th>pcs шт.</th> </tr> </thead> <tbody> <tr><td>FNL 5A</td><td>1</td></tr> <tr><td>FNL 7,5A</td><td>2</td></tr> <tr><td>FNL 10A</td><td>2</td></tr> <tr><td>FNL 15A</td><td>2</td></tr> <tr><td>FNL 20A</td><td>2</td></tr> <tr><td>FNL 25A</td><td>2</td></tr> <tr><td>FNL 30A</td><td>1</td></tr> </tbody> </table> <p>(140 x 80 x 5 mm)</p>	Type / Тип	pcs шт.	FNL 5A	1	FNL 7,5A	2	FNL 10A	2	FNL 15A	2	FNL 20A	2	FNL 25A	2	FNL 30A	1		<table border="1"> <thead> <tr> <th>Type / Тип</th> <th>pcs шт.</th> </tr> </thead> <tbody> <tr><td>FTL 5A</td><td>1</td></tr> <tr><td>FTL 7,5A</td><td>2</td></tr> <tr><td>FTL 10A</td><td>2</td></tr> <tr><td>FTL 15A</td><td>2</td></tr> <tr><td>FTL 20A</td><td>2</td></tr> <tr><td>FTL 25A</td><td>2</td></tr> <tr><td>FTL 30A</td><td>1</td></tr> </tbody> </table> <p>(140 x 80 x 5 mm)</p>	Type / Тип	pcs шт.	FTL 5A	1	FTL 7,5A	2	FTL 10A	2	FTL 15A	2	FTL 20A	2	FTL 25A	2	FTL 30A	1
Type / Тип	pcs шт.																																																				
FLL 5A	1																																																				
FLL 7,5A	2																																																				
FLL 10A	2																																																				
FLL 15A	2																																																				
FLL 20A	2																																																				
FLL 25A	2																																																				
FLL 30A	1																																																				
Type / Тип	pcs шт.																																																				
FNL 5A	1																																																				
FNL 7,5A	2																																																				
FNL 10A	2																																																				
FNL 15A	2																																																				
FNL 20A	2																																																				
FNL 25A	2																																																				
FNL 30A	1																																																				
Type / Тип	pcs шт.																																																				
FTL 5A	1																																																				
FTL 7,5A	2																																																				
FTL 10A	2																																																				
FTL 15A	2																																																				
FTL 20A	2																																																				
FTL 25A	2																																																				
FTL 30A	1																																																				

CONTINENTAL FUSES (TORPEDO)

F151, F152, F153

Комплекты предохранителей торпедо – упаковка блистер

Order code / Каталогный номер		Order code / Каталогный номер		Order code / Каталогный номер																							
F151.000.000		F152.000.000		F153.000.000																							
	<table border="1"> <thead> <tr> <th>Type / Тип</th> <th>pcs шт.</th> </tr> </thead> <tbody> <tr><td>FC 8A</td><td>5</td></tr> <tr><td>FC 16A</td><td>5</td></tr> </tbody> </table> <p>(132 x 92 x 5 mm)</p>	Type / Тип	pcs шт.	FC 8A	5	FC 16A	5		<table border="1"> <thead> <tr> <th>Type / Тип</th> <th>pcs шт.</th> </tr> </thead> <tbody> <tr><td>FC 5A</td><td>1</td></tr> <tr><td>FC 8A</td><td>6</td></tr> <tr><td>FC 16A</td><td>2</td></tr> <tr><td>FC 25A</td><td>1</td></tr> </tbody> </table> <p>(132 x 92 x 5 mm)</p>	Type / Тип	pcs шт.	FC 5A	1	FC 8A	6	FC 16A	2	FC 25A	1		<table border="1"> <thead> <tr> <th>Type / Тип</th> <th>pcs шт.</th> </tr> </thead> <tbody> <tr><td>FC 8A</td><td>8</td></tr> <tr><td>FC 16A</td><td>2</td></tr> </tbody> </table> <p>(132 x 92 x 5 mm)</p>	Type / Тип	pcs шт.	FC 8A	8	FC 16A	2
Type / Тип	pcs шт.																										
FC 8A	5																										
FC 16A	5																										
Type / Тип	pcs шт.																										
FC 5A	1																										
FC 8A	6																										
FC 16A	2																										
FC 25A	1																										
Type / Тип	pcs шт.																										
FC 8A	8																										
FC 16A	2																										

BLADE FUSES - SPECIAL BOX PACKING

Плоские предохранители - сборная упаковка, коробка

FL, FN, FT
Pack

Low profile MINI			FL pack
Order code / Каталогный номер			FL00.999.070
Type	Color	pcs	
Тип	Цвет	шт.	
FL 5A		10	
FL 7,5A		10	
FL 10A		10	
FL 15A		10	
FL 20A		10	
FL 25A		10	
FL 30A		10	

70 pcs / шт.



(110 x 85 x 25 mm)

MINI			FN pack
Order code / Каталогный номер			FN00.999.100
Type	Color	pcs	
Тип	Цвет	шт.	
FN 5A		10	
FN 7,5A		10	
FN 10A		20	
FN 15A		20	
FN 20A		20	
FN 25A		10	
FN 30A		10	

100 pcs / шт.



(110 x 85 x 25 mm)

ATO			FT pack
Order code / Каталогный номер			FT00.999.100
Type	Color	pcs	
Тип	Цвет	шт.	
FT 3A		2	
FT 4A		2	
FT 5A		10	
FT 7,5A		10	
FT 10A		20	
FT 15A		20	
FT 20A		10	
FT 25A		10	
FT 30A		10	
FT 40A		6	

100 pcs / шт.









(110 x 85 x 35 mm)

GLOW BLADE FUSES - SPECIAL BOX PACKING

Плоские предохранители с индикатором LED – сборная упаковка, коробка

FLL, FNL, FTL







Pack

GLOW Low profile MINI			FLL pack
Order code / Каталогный номер			FLL0.999.030
Type	Color	pcs	
Тип	Цвет	шт.	
FLL 5A		2	
FLL 7,5A		4	
FLL 10A		6	
FLL 15A		6	
FLL 20A		4	
FLL 25A		4	
FLL 30A		4	

30 pcs / шт.









(110 x 85 x 25 mm)

GLOW MINI			FNL pack
Order code / Каталогный номер			FNL0.999.030
Type	Color	pcs	
Тип	Цвет	шт.	
FNL 5A		2	
FNL 7,5A		4	
FNL 10A		6	
FNL 15A		6	
FNL 20A		4	
FNL 25A		4	
FNL 30A		4	

30 pcs / шт.



(110 x 85 x 25 mm)

GLOW ATO			FTL pack
Order code / Каталогный номер			FTL00.999.070
Type	Color	pcs	
Тип	Цвет	шт.	
FTL 5A		2	
FTL 7,5A		3	
FTL 10A		6	
FTL 15A		6	
FTL 20A		6	
FTL 25A		3	
FTL 30A		4	

30 pcs / шт.



(110 x 85 x 25 mm)

MICRO2, MICRO3 BLADE FUSES

Плоские предохранители MICRO2, MICRO3 - упаковка мульти бокс

FRR Multibox

MICRO2, MICRO3			FRR Multibox		
Order code / Каталогный номер			FBOX.009.120		
Type	Color	pcs	Type	Color	pcs
Тип	Цвет	шт.	Тип	Цвет	шт.
FR02 5A		10			
FR02 7,5A		10			
FR02 10A		20			
FR02 15A		10			
FR02 20A		10			
FR02 25A		10			
FR02 30A		10			
FR03 5A		10			
FR03 7,5A		10			
FR03 10A		10			
FR03 15A		10			

120 pcs / шт.



(180 x 130 x 25 mm)

LOW PROFILE MINI, MINI BLADE FUSES

Плоские предохранители Low Profile MINI, MINI - упаковка мульти бокс

FLN Multibox

Low profile MINI, MINI			FLN Multibox		
Order code / Каталогный номер			FBOX.001.320		
Type	Color	pcs	Type	Color	pcs
Тип	Цвет	шт.	Тип	Цвет	шт.
FL 2A		10	FN 2A		10
			FN 3A		10
			FN 4A		10
FL 5A		20	FN 5A		20
FL 7,5A		20	FN 7,5A		20
FL 10A		20	FN 10A		20
FL 15A		20	FN 15A		20
FL 20A		20	FN 20A		20
FL 25A		20	FN 25A		20
FL 30A		20	FN 30A		20

150 pcs / шт. 170 pcs / шт.



(210 x 120 x 30 mm)

MINI BLADE FUSES

FN Multibox

Плоские предохранители MINI - упаковка мульти бокс

MINI		FN Multibox
Order code / Каталогный номер		FBOX.002.360
Type	Color	pcs
Тип	Цвет	шт.
FN 2A	Grey	20
FN 3A	Purple	20
FN 4A	Pink	20
FN 5A	Brown	40
FN 7,5A	Dark Brown	40
FN 10A	Red	60
FN 15A	Blue	40
FN 20A	Yellow	40
FN 25A	White	40
FN 30A	Green	40

360 pcs / шт.



(210 x 120 x 30 mm)

MINI BLADE FUSES

FNR Multibox

Плоские предохранители MINI - упаковка мульти бокс

MINI		FNR Multibox
Order code / Каталогный номер		FBOX.003.210
Type	Color	pcs
Тип	Цвет	шт.
FN 2A	Grey	10
FN 3A	Purple	10
FN 4A	Pink	10
FN 5A	Brown	20
FN 7,5A	Dark Brown	20
FN 10A	Red	40
FN 15A	Blue	40
FN 20A	Yellow	20
FN 25A	White	20
FN 30A	Green	20

210 pcs / шт.



(180 x 130 x 25 mm)

ATO BLADE FUSES, CONTINENTAL FUSES
FCT Multibox

Плоские предохранители АТО, предохранители торпедо – упаковка мульти бокс

ATO, CONTINENTAL			FCT Multibox		
Order code / Каталогный номер			FBOX.004.215		
Type	Color	pcs	Type	Color	pcs
Тип	Цвет	шт.	Тип	Цвет	шт.
FT 1A	■	5	FC 5A	■	10
FT 2A	■	5	FC 8A	□	20
FT 3A	■	5	FC 16A	■	20
FT 4A	■	5	FC 25A	■	10
FT 5A	■	10			
FT 7,5A	■	15			
FT 10A	■	30			
FT 15A	■	15			
FT 20A	■	15			
FT 25A	□	15			
FT 30A	■	15			
FT 35A	■ ■	10			
FT 40A	■	10			
155 pcs / шт.			60 pcs / шт.		



(210 x 120 x 30 mm)

ATO BLADE FUSES
FT Multibox

Плоские предохранители АТО – упаковка мульти бокс

ATO		FT Multibox	
Order code / Каталогный номер		FBOX.005.195	
Type	Color	pcs	
Тип	Цвет	шт.	
FT 1A	■	5	
FT 2A	■	5	
FT 3A	■	5	
FT 4A	■	5	
FT 5A	■	10	
FT 7,5A	■	15	
FT 10A	■	30	
FT 15A	■	30	
FT 20A	■	30	
FT 25A	□	20	
FT 30A	■	20	
FT 35A	■ ■	10	
FT 40A	■	10	
195 pcs / шт			



(210 x 120 x 30 mm)

ATO BLADE FUSES

FTR Multibox

Плоские предохранители ATO - упаковка мульти бокс

ATO		FTR Multibox
Order code / Каталогный номер		FBOX.006.110
Type	Color	pcs
Тип	Цвет	шт.
FT1A	■	5
FT 2A	■	5
FT 3A	■	5
FT 4A	■	5
FT 5A	■	10
FT 7,5A	■	10
FT 10A	■	15
FT 15A	■	15
FT 20A	■	15
FT 25A	□	10
FT 30A	■	10
FT 40A	■	5

110 pcs / шт.



(180 x 130 x 25 mm)

MAXI BLADE FUSES

FXR Multibox

Плоские предохранители MAXI - упаковка мульти бокс

MAXI		FXR Multibox
Order code / Каталогный номер		FBOX.007.036
Type	Color	pcs
Тип	Цвет	шт.
FX 20A	■	3
FX 25A	■	3
FX 30A	■	6
FX 40A	■	6
FX 50A	■	6
FX 60A	■	3
FX 70A	■	3
FX 80A	□	3
FX 100A	■	3

36 pcs / шт.



(180 x 130 x 25 mm)

MINI, ATO, MAXI BLADE FUSES

Плоские предохранители MINI, ATO, MAXI – упаковка мульти бокс

FNTX Multibox

MINI, ATO, MAXI			FNTX Multibox		
Order code / Каталогный номер			FBOX.008.257		
Type	Color	pcs	Type	Color	pcs
Тип	Цвет	шт.	Тип	Цвет	шт.
FN 5A		20	FT 5A		15
FN 7,5A		20	FT 7,5A		15
FN 10A		20	FT 10A		15
FN 15A		20	FT 15A		15
FN 20A		20	FT 20A		15
FN 25A		20	FT 25A		15
FN 30A		20	FT 30A		15
			FX 30A		3
			FX 40A		3
			FX 50A		3
			FX 60A		3
140 pcs / шт.			105/12 pcs / шт.		



(210 x 120 x 30 mm)

BLADE FUSE TESTER

Тестер для плоских предохранителей

P150

Order code - packing unit: 1 pc
Каталожный номер – упаковка: 1 шт.

P150.000.000



- tester / puller for blade fuses Low Profile MINI, MINI, ATO, MAXI
- supply: 2 x 1,5V batteries (built –in)
- тестер с пинцетом для демонтажа и прозвонки плоских предохранителей Low Profile MINI, MINI, ATO, MAXI
- питание: 2x 1,5V (батарейки в корпусе)

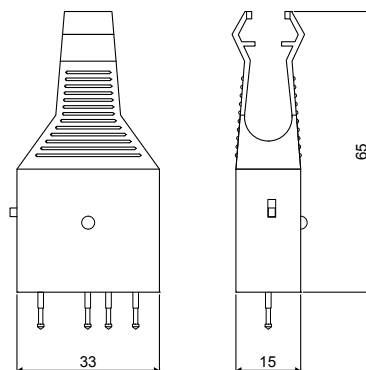

FUSE HOLDERS

Держатели для предохранителей

Fuse holders for blade fuses MINI Держатели для плоских предохранителей MINI.....	56
Fuse holders for blade fuses ATO Держатели для плоских предохранителей ATO	57
Fuse holders for blade fuses MAXI Держатели для плоских предохранителей MAXI.....	62
Fuse holder for fuses MIDI Держатель для предохранителей MIDI	63
Fuse holder for fuses MEGA Держатель для предохранителей MEGA	64
Fuse holder for strip fuses Держатель для ленточных предохранителей	64
Fuse holders for cartridge fuses Держатели для предохранителей картриджного типа	65
Self stripping splice connector Ответвитель для проводов.....	66

Dimensions in mm / Размеры в мм

HOLDER FOR MINI BLADE FUSES
P531

Держатель для плоских предохранителей MINI

Order code - packing unit: 1 pc

Каталогный номер – упаковка: 1 шт.

P531.000.000

Description:

- black leads 2,1 mm² / 110 mm
- for fuses FN 2A – 20A / 32V
- protective cover

Описание:

- чёрные провода 2,1 mm² / 110 mm
- для предохранителей FN 2A – 20A / 32V
- предохранительная крышка

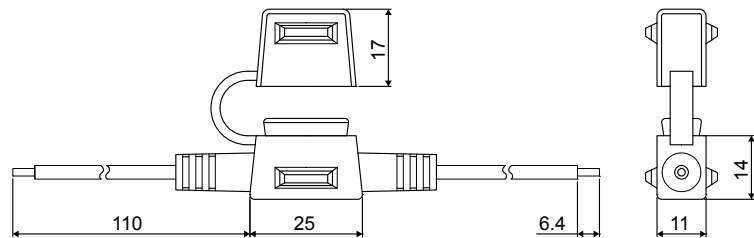
HOLDER FOR MINI BLADE FUSES
P532

Держатель для плоских предохранителей MINI

Order code - packing unit: 1 pc

Каталогный номер – упаковка: 1 шт.

P532.000.000

Description:

- orange leads 3,3 mm² / 110 mm
- for fuses FN 2A – 30A / 32V
- protective cover

Описание:

- оранжевые провода 3,3 mm² / 110 mm
- для предохранителей FN 2A – 30A / 32V
- предохранительная крышка

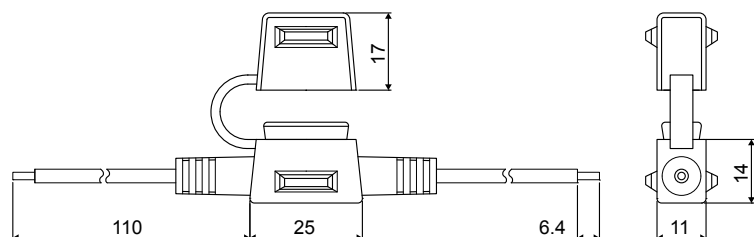

PCB HOLDERS FOR MINI BLADE FUSES

P533, P534

PCB держатели для плоских предохранителей MINI

Order code - packing unit: 1 pc

Каталожный номер – упаковка: 1 шт.

P533.000.000**P534.000.000**

Description:

P533: for fuses FN 2A – 15A / 32V

- vertical mounting

P534: for fuses FN 2A – 20A / 32V

- vertical mounting

Описание:

P533: для предохранителей FN 2A – 15A / 32V

- вертикальный монтаж на печатную плату

P534: для предохранителей FN 2A – 20A / 32V

- вертикальный монтаж на печатную плату

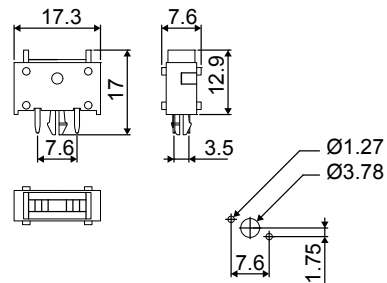

HOLDER FOR ATO BLADE FUSES

P541

Держатель для плоских предохранителей ATO

Order code - packing unit: 1 pc

Каталожный номер – упаковка: 1 шт.

P541.000.000

Description:

- black leads 2,1 mm² / 102 mm

- for fuses FT 1A – 20A / 32V

- protective cover

Описание:

- чёрные провода 2,1 mm² / 102 mm

- для предохранителей FT 1A – 20A / 32V

- предохранительная крышка

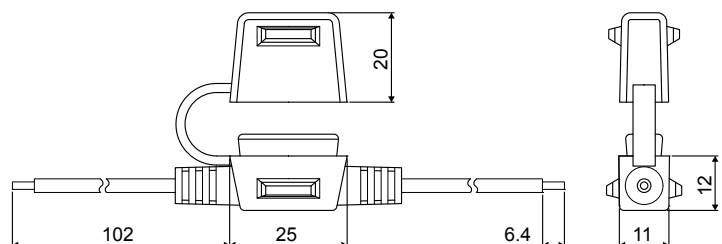

HOLDER FOR ATO BLADE FUSES
P542

Держатель для плоских предохранителей АТО

Order code - packing unit: 1 pc
Каталожный номер – упаковка: 1 шт.

P542.000.000
Description:

- orange leads 3,3 mm² / 102 mm
- for fuses FT 1A – 30A / 32V
- protective cover

Описание:

- оранжевые провода 3,3 mm² / 102 mm
- для предохранителей FT 1A – 30A / 32V
- предохранительная крышка

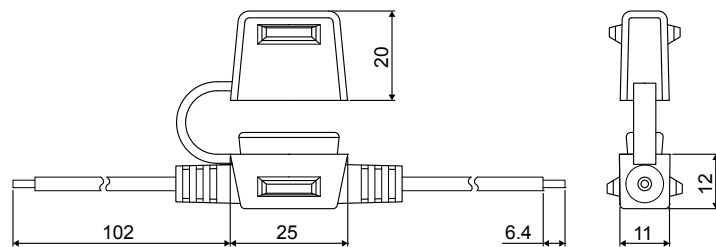
HOLDERS FOR ATO BLADE FUSES
P520, P521, P522

Держатели для плоских предохранителей АТО

Order code	Amperage	Leads	Terminals	Fuses
Каталожный №	Ном. ток	Провода	Контакты	Предохран.
P520.001.000	1A - 20 A	1,5 – 2,5 mm ² / –	2	1
P520.002.000	1A - 40 A	4 – 6 mm ² / –	2	1
P521.001.000	1A - 20 A	1,5 mm ² / 2x100 mm	2	1
P521.002.000	1A - 40 A	4 mm ² / 2 x 100 mm	2	1
P522.001.000	1A - 20 A	1,5 mm ² / 200 mm	2	1
P522.002.000	1A - 40 A	4 mm ² / 200 mm	2	1

Description:

- P520 (1pc): loose housing, loose contacts
 P521, P522 (1pc): housing with contacts
 • for fuses FT 1A – 40A / 32V – see order code
 • contact temperature max. 110 °C

Описание:

- P520 (1шт): отдельный корпус и контакты
 P521, P522 (1шт): корпус с контактами и проводом
 • для предохранителей FT 1A – 40A / 32V - см. каталожный №
 • температура контактов макс. 110 °C

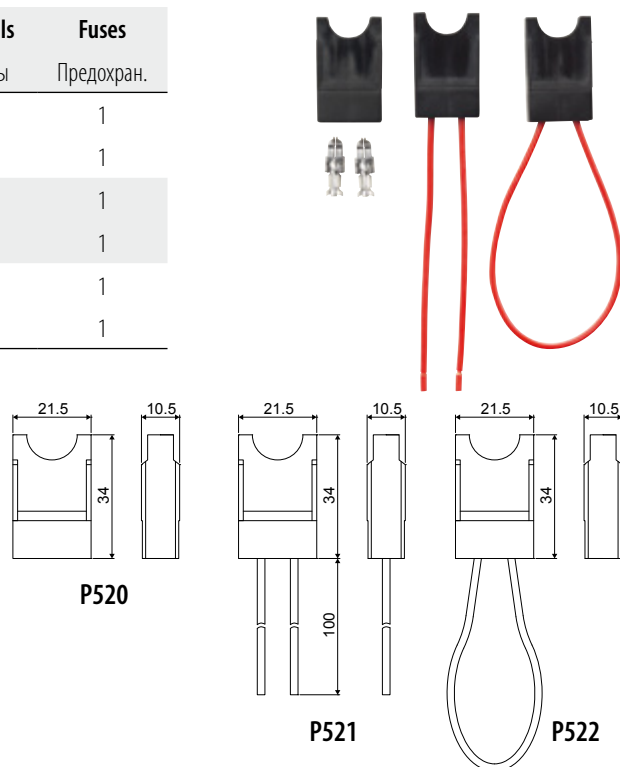

BLOCK HOLDERS FOR ATO BLADE FUSES

P543, P544, P545

Составные держатели для плоских предохранителей АТО

Order code - packing unit: 1 pc

Каталожный номер - упаковка: 1 шт.

P543.000.000

Holder unit P543 (1 pc):

- loose housing, cover, contacts
- for wire cross section $0,5 \text{ mm}^2 - 1,0 \text{ mm}^2$
- for fuses FT 1A – 10A / 32V
- contact temperature max. $130 \text{ }^\circ\text{C}$

Комплект P543 (1 шт.):

- отдельный корпус, отдельная крышка, отдельные контакты для провода сечения $0,5 \text{ mm}^2 - 1,0 \text{ mm}^2$
- для предохранителей FT 1A – 10A / 32V
- температура контактов макс. $130 \text{ }^\circ\text{C}$

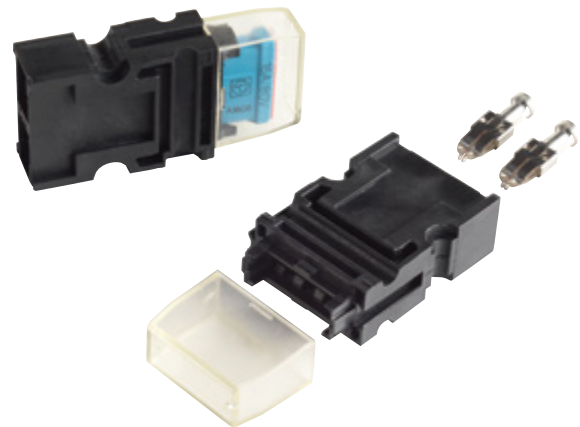

Order code - packing unit: 1 pc

Каталожный номер - упаковка: 1 шт.

P544.000.000

Holder unit P544 (1 pc):

- loose housing, cover, contacts
- for wire cross section $1,5 \text{ mm}^2 - 2,5 \text{ mm}^2$
- for fuses FT 1A – 20A / 32V
- contact temperature max. $130 \text{ }^\circ\text{C}$

Комплект P544 (1 шт.):

- отдельный корпус, отдельная крышка, отдельные контакты для провода сечения $1,5 \text{ mm}^2 - 2,5 \text{ mm}^2$
- для предохранителей FT 1A – 20A / 32V
- температура контактов макс. $130 \text{ }^\circ\text{C}$

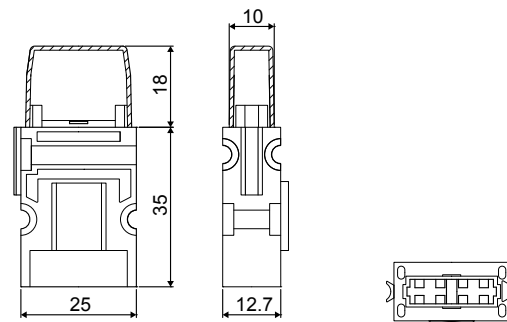

Order code - packing unit: 1 pc

Каталожный номер - упаковка: 1 шт.

P545.000.000

Holder unit P545 (1 pc):

- loose housing, cover, contacts
- for wire cross section $4 \text{ mm}^2 - 6 \text{ mm}^2$
- for fuses FT 1A – 40A / 32V
- contact temperature max. $130 \text{ }^\circ\text{C}$

Комплект P545 (1 шт.):

- отдельный корпус, отдельная крышка, отдельные контакты для провода сечения $4 \text{ mm}^2 - 6 \text{ mm}^2$
- для предохранителей FT 1A – 40A / 32V
- температура контактов макс. $130 \text{ }^\circ\text{C}$

Block of holders - состав держателей:

- 2 pcs - 10 pcs of holder unit P54x
for 2 pcs - 10 pcs fuses FT 1A – 40A
- 2 шт. - 10 шт. держателей P54x
для 2 шт. - 10 шт. предохранителей FT 1A – 40A

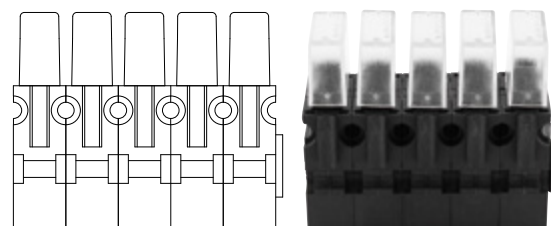

HOLDERS FOR ATO BLADE FUSES
P501...P505

Держатели для плоских предохранителей АТО

Order code Каталожный №	A (mm)	B (mm)	Fuses Предохран.	Terminals Контакты	Amperage Ном. ток	Leads Провода
P501.001.000	28	42	2	4	1 - 20 A	1,5 - 2,5 mm ²
P501.002.000				4	1 - 40 A	4 - 6 mm ²
P502.001.000	52,5	66,5	4	8	1 - 20 A	1,5 - 2,5 mm ²
P502.002.000				8	1 - 40 A	4 - 6 mm ²
P503.001.000	77	91	6	12	1 - 20 A	1,5 - 2,5 mm ²
P503.002.000				12	1 - 40 A	4 - 6 mm ²
P504.001.000	101,5	115,5	8	16	1 - 20 A	1,5 - 2,5 mm ²
P504.002.000				16	1 - 40 A	4 - 6 mm ²
P505.001.000	126	140	10	20	1 - 20 A	1,5 - 2,5 mm ²
P505.002.000				20	1 - 40 A	4 - 6 mm ²

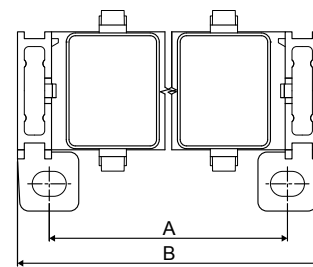
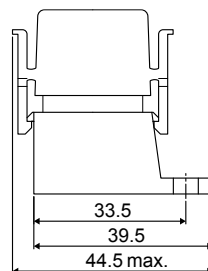
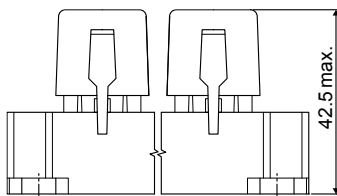

Holder unit P50x (1 pc):

- loose housing, cover, contacts
- for 2 – 10 pcs fuses FT 1A – 40A / 32V - see order code
- contact temperature max. 110 °C
- mounting by screw M5
(fuses and wires are not included into the shipment)

Комплект P50x (1 шт.):

- отдельный корпус, отдельная крышка, отдельные контакты
- для 2 - 10 шт. предохранителей FT 1A – 40A / 32V
- см. каталожный номер
- температура контактов макс. 110 °C
- крепление винтами М5
(предохранитель и провод не входит в комплект)

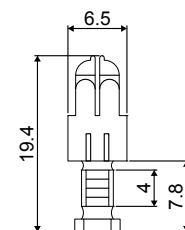

HOLDERS FOR ATO BLADE FUSES

P511...P515

Держатели для плоских предохранителей АТО

Order code	A	B	Fuses	Terminals	Amperage	Leads
Каталожный №	(mm)	(mm)	Предохран.	Контакты	Ном. ток	Провода
P511.001.000	43	55	2	4	1 - 20 A	1,5 - 2,5 mm ²
P511.002.000				4	1 - 40 A	4 - 6 mm ²
P512.001.000	67	79	4	8	1 - 20 A	1,5 - 2,5 mm ²
P512.002.000				8	1 - 40 A	4 - 6 mm ²
P513.001.000	92	104	6	12	1 - 20 A	1,5 - 2,5 mm ²
P513.002.000				12	1 - 40 A	4 - 6 mm ²
P514.001.000	117	129	8	16	1 - 20 A	1,5 - 2,5 mm ²
P514.002.000				16	1 - 40 A	4 - 6 mm ²
P515.001.000	141	153	10	20	1 - 20 A	1,5 - 2,5 mm ²
P515.002.000				20	1 - 40 A	4 - 6 mm ²

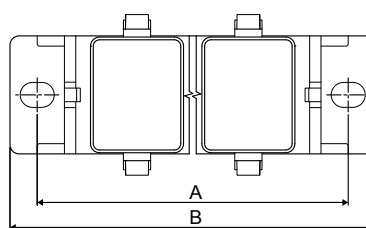
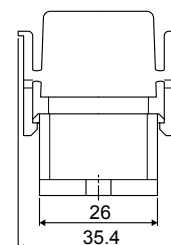
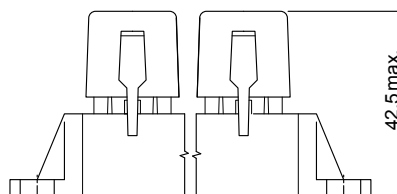

Holder unit P51x (1pc):

- loose housing, cover, contacts
 - for 2 – 10 pcs fuses FT 1A – 40A / 32V - see order code
 - contact temperature max. 110 °C
 - mounting by screw M5
- (fuses and wires are not included into the shipment)*

Комплект P51x (1 шт.):

- отдельный корпус, отдельная крышка, отдельные контакты
 - для 2-10 шт. предохранителей FT 1A – 40A / 32V
 - см. каталожный номер
 - температура контактов макс. 110 °C
 - крепление винтами М5
- (предохранитель и провод не входит в комплект)*

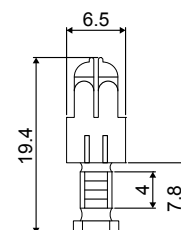

PCB HOLDER FOR ATO BLADE FUSES

P546

PCB держатель для плоских предохранителей ATO

Order code - packing unit: 1 pc

Каталожный номер – упаковка: 1 шт.

P546.000.000

Description:

- for fuses FT 1A – 40A / 32V
- vertical mounting
- contact temperature max. 130 °C

Описание:

- для предохранителей FT 1A – 40A / 32V
- вертикальный монтаж на печатную плату
- температура контактов макс. 130 °C

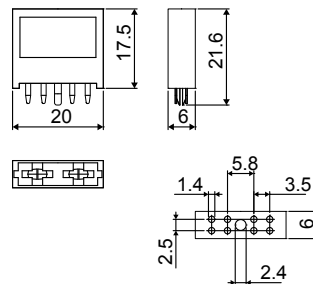
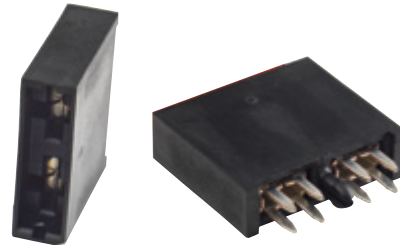

HOLDER FOR MAXI BLADE FUSES

P561

Держатель для плоских предохранителей MAXI

Order code - packing unit: 1 pc

Каталожный номер – упаковка: 1 шт.

P561.000.000

Holder unit P561 (1pc):

- loose housing, cover, screws, terminals (2 + 2 pcs)
- for wire cross section 2,5 mm² – 6 mm²
- for wire cross section 5 mm² – 10 mm²
- for fuses FX 20A – 60A / 32V

Комплект P561 (1 шт.):

- отдельный корпус, отдельная крышка, отдельные болты
- отдельные наконечники проводов (2 + 2 шт.)
- для проводов с сечением 2,5 mm² – 6 mm²
- для проводов с сечением 5 mm² – 10 mm²
- для предохранителей FX 20A – 60A / 32V

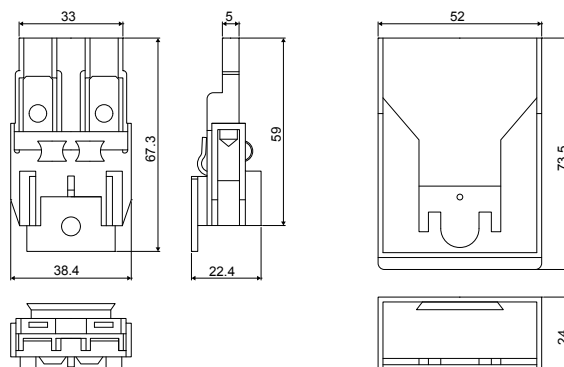

HOLDER FOR MAXI BLADE FUSES

P562

Держатель для плоских предохранителей MAXI

Order code - packing unit: 1 pc

Каталожный номер – упаковка: 1 шт.

P562.000.000

Description:

- black leads 10 mm² / 127 mm
- for fuses FX 20A – 60A / 32V
- protective cover

Описание:

- чёрные провода 10 mm² / 127 mm
- для предохранителей FX 20A – 60A / 32V
- предохранительная крышка

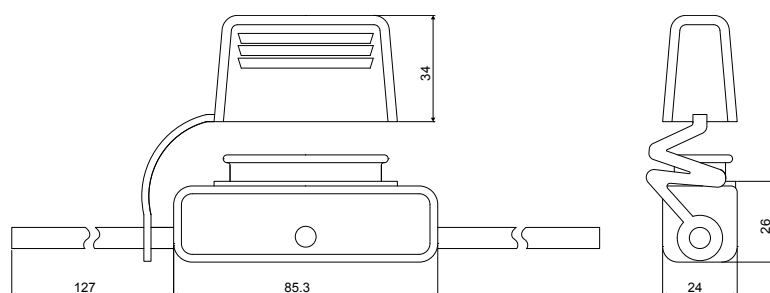

HOLDER FOR MIDI FUSES

P570

Держатель для предохранителей MIDI

Order code - packing unit: 1 pc

Каталожный номер – упаковка: 1 шт.

P570.000.000

Description:

- for fuses FD 30A – 150A / 32V
- protective cover

Описание:

- для предохранителей FD 30A – 150A / 32V
- предохранительная крышка

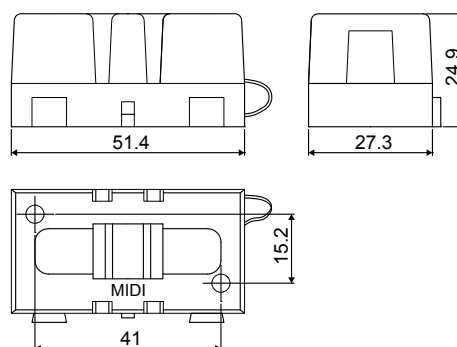

HOLDER FOR MEGA FUSES

P571

Держатель для предохранителей MEGA

Order code - packing unit: 1 pc
Каталожный номер – упаковка: 1 шт.

P571.000.000
Description:

- for fuses FG 40A – 500A / 32V
- protective cover

Описание:

- для предохранителей FG 40A – 500A / 32V
- предохранительная крышка

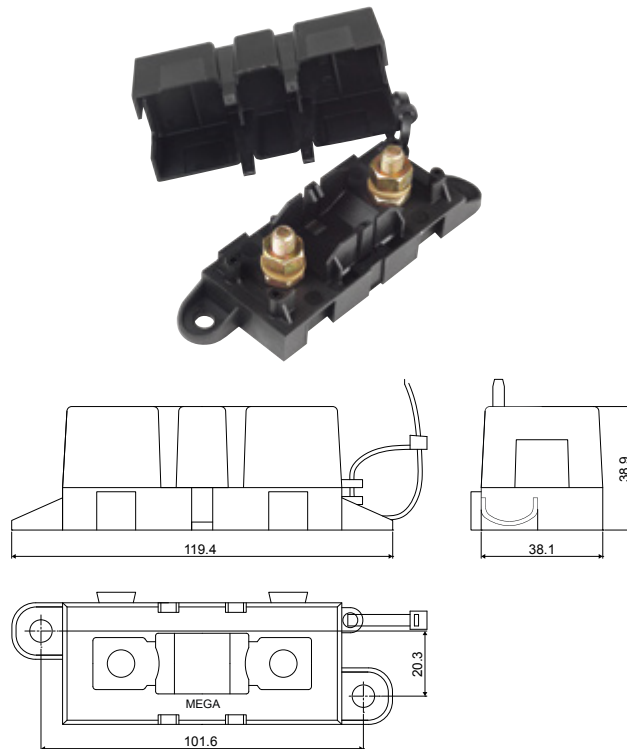

HOLDER FOR STRIP FUSES

P523

Держатель для ленточных предохранителей

Order code - packing unit: 1 pc
Каталожный номер – упаковка: 1 шт.

P523.000.000
Description:

- for fuses FS 30A – 175A / 32V (spacing 30 mm)
- for fuses FS1 25A – 150A / 36V
- temperature resistance: -30 ... +100 °C

Описание:

- для предохранителей FS 30A – 175A / 32V (расстояние 30 мм)
- для предохранителей FS1 25A – 150A / 36V
- термостойкость: -30 ... +100 °C

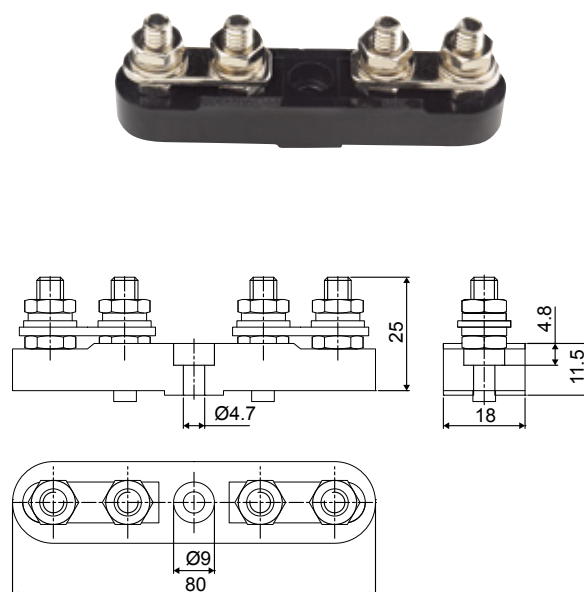

HOLDERS FOR CARTRIDGE FUSES FJ16

P581, P582

Держатели для предохранителей картриджного типа FJ16

Order code - packing unit: 1 pc

Каталожный номер - упаковка: 1 шт.

P581.000.000

P582.000.000

Description:

- red leads 8 mm² / 110 mm
- for fuses FJ16 20A – 60A / 32V
- protective cover
- temperature resistance: -40 ... +125 °C

P 581: mounting brackets

P 582: mounting thru-hole \varnothing 4 mm

Описание:

- красные провода 8 mm² / 110 mm
- для предохранителей FJ16 20A – 60A / 32V
- предохранительная крышка
- термостойкость: -40 ... +125 °C

P581: монтажный держатель

P582: монтажный проем \varnothing 4 mm

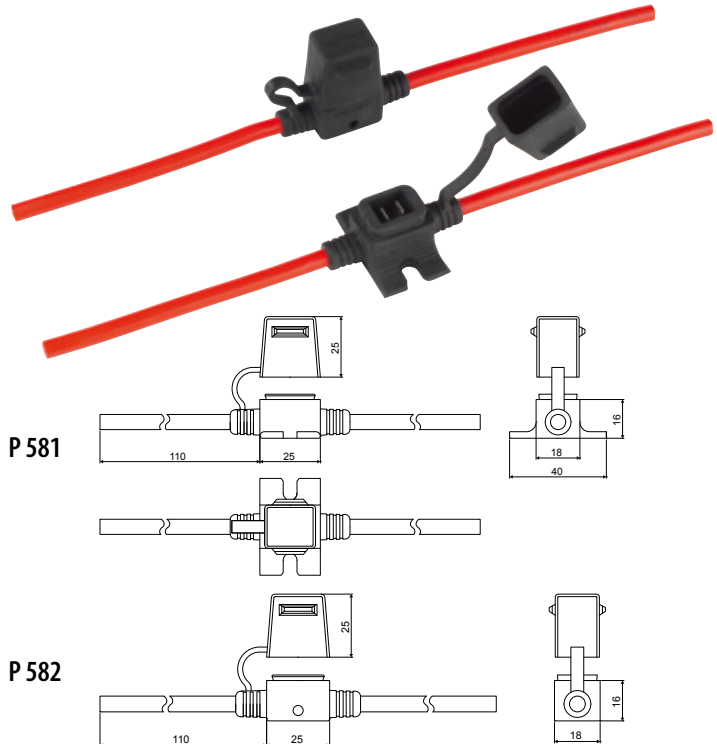

HOLDERS FOR CARTRIDGE FUSES FJ17

P583, P584

Держатели для предохранителей картриджного типа FJ17

Order code - packing unit: 1 pc

Каталожный номер - упаковка: 1 шт.

P583.000.000

P584.000.000

Description:

- red leads 8 mm² / 110 mm
- for fuses FJ17 20A – 60A / 58V
- protective cover
- temperature resistance: -40 ... +125 °C

P 583: mounting brackets

P 584: mounting thru-hole \varnothing 4 mm

Описание:

- красные провода 8 mm² / 110 mm
- для предохранителей FJ17 20A – 60A / 58V
- предохранительная крышка
- термостойкость: -40 ... +125 °C

P583: монтажный держатель

P584: монтажный проем \varnothing 4 mm

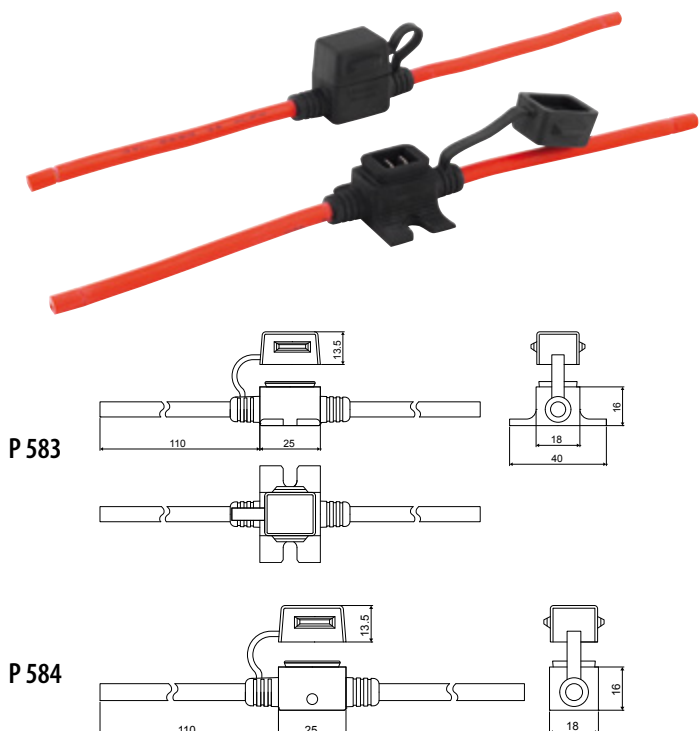

SELF STRIPPING SPLICE CONNECTOR FOR TWO CABLES
P101, P102, P103

Ответвитель для соединения 2 проводов

Connector P101, P102, P103:

- housing material: nylon
- strip material: brass
- max. temperature: 105 °C

Ответвитель P101, P102, P103:

- корпус: нейлон
- нож: латунь
- температура макс: 105 °C

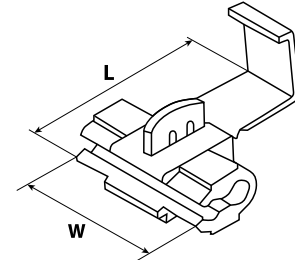

Type	Packing unit - order code / Упаковка - каталожный номер		
Тип	1 pcs / шт.	10 pcs / шт.	100 pcs / шт.
P101	P101.000.001	P101.000.010	P101.000.100

- color red, wire cross section: 0,25 – 1,65 mm²
- цвет красный, сечение провода: 0,25 – 1,65 mm²



W x L = 20 x 31

Type	Packing unit - order code / Упаковка - каталожный номер		
Тип	1 pcs / шт.	10 pcs / шт.	100 pcs / шт.
P102	P102.000.001	P102.000.010	P102.000.100

- color blue, wire cross section: 1,04 – 2,63 mm²
- цвет синий, сечение провода: 1,04 – 2,63 mm²



W x L = 20 x 31

Type	Packing unit - order code / Упаковка - каталожный номер		
Тип	1 pcs / шт.	10 pcs / шт.	100 pcs / шт.
P103	P103.000.001	P103.000.010	P103.000.100

- color yellow, wire cross section: 2,63 – 6,64 mm²
- цвет жёлтый, сечение провода: 2,63 – 6,64 mm²



W x L = 20 x 32

Other products - ignition parts

Остальной ассортимент - компоненты системы зажигания

Ignition leads sets

Комплекты проводов зажигания



Ignition coils

Катушки зажигания



Coil on plug boots

Наконечники катушки зажигания



Ignition leads and coils - combined ignition system

Провода и катушки зажигания
- комбинированная система зажигания



2016 - 2017

AUTOMOBILOVÉ ŽÁROVKY A POJISTKY **AUTOMOTIVE BULBS & FUSES**

АВТОМОБИЛЬНЫЕ ЛАМПЫ И ПРЕДОХРАНИТЕЛИ

FAHRZEUGLAMPEN UND SICHERUNGEN

LAMPARAS Y FUSIBLES PARA AUTOMOVILES

LAMPES ET FUSIBLES POUR VOITURES

LAMPADE E FUSIBILI PER AUTO



2016 - 2017

AUTOMOBILOVÉ ŽÁROVKY A POJISTKY
AUTOMOTIVE BULBS & FUSES

АВТОМОБИЛЬНЫЕ ЛАМПЫ И ПРЕДОХРАНИТЕЛИ
FAHRZEUGLAMPEN UND SICHERUNGEN

LAMPARAS Y FUSIBLES PARA AUTOMOVILES

LAMPES ET FUSIBLES POUR VOITURES

LAMPADE E FUSIBILI PER AUTO

www.tesla-blatna.cz

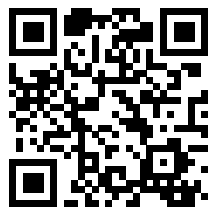

 **TESLA** | trusted by generations

TESLA BLATNÁ, a.s., Palackého 644, 388 15 Blatná, Czech Republic
e-mail: sales@tesla-blatna.cz, phone: +420 383 415 354, telefax: +420 383 415 300
www.tesla-blatna.cz